

# PALERMO 1 - NÁVOD SOTRA

## Výrobní číslo 2853400

*Art. Nr. 2853400*

1/23



17.01.2023

# Výrobní číslo 2853400 - půdorysný plán

Groundplan - Grundplan - Plan de masse -  
Planimetria - Plattegrond - Põhiplaan

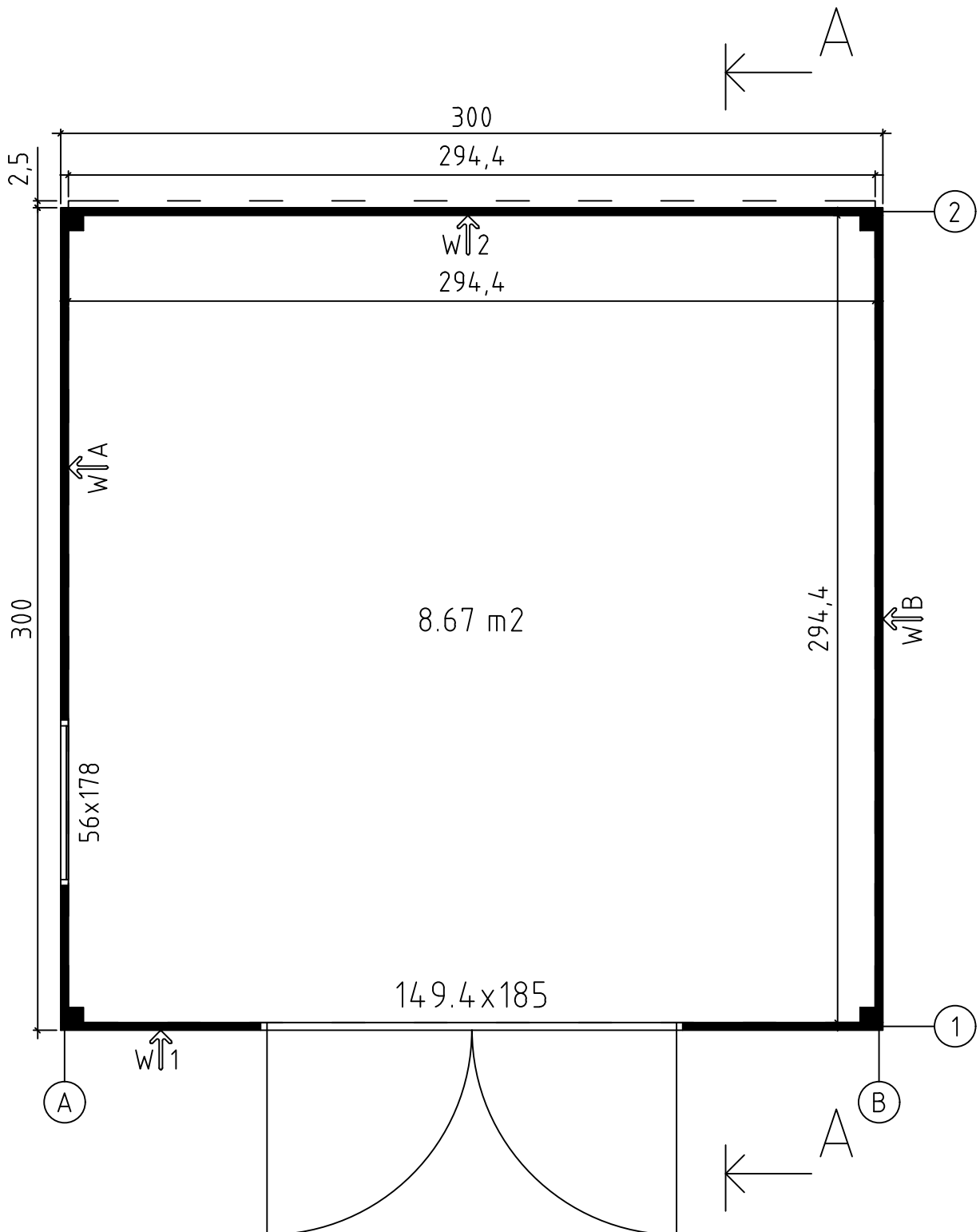

Art. Nr. 2853400

# Výrobní číslo 2853400 - základy

Foundation - Fundament - Fondation -  
Fondamenta - Fundering - Immutatud alusraam

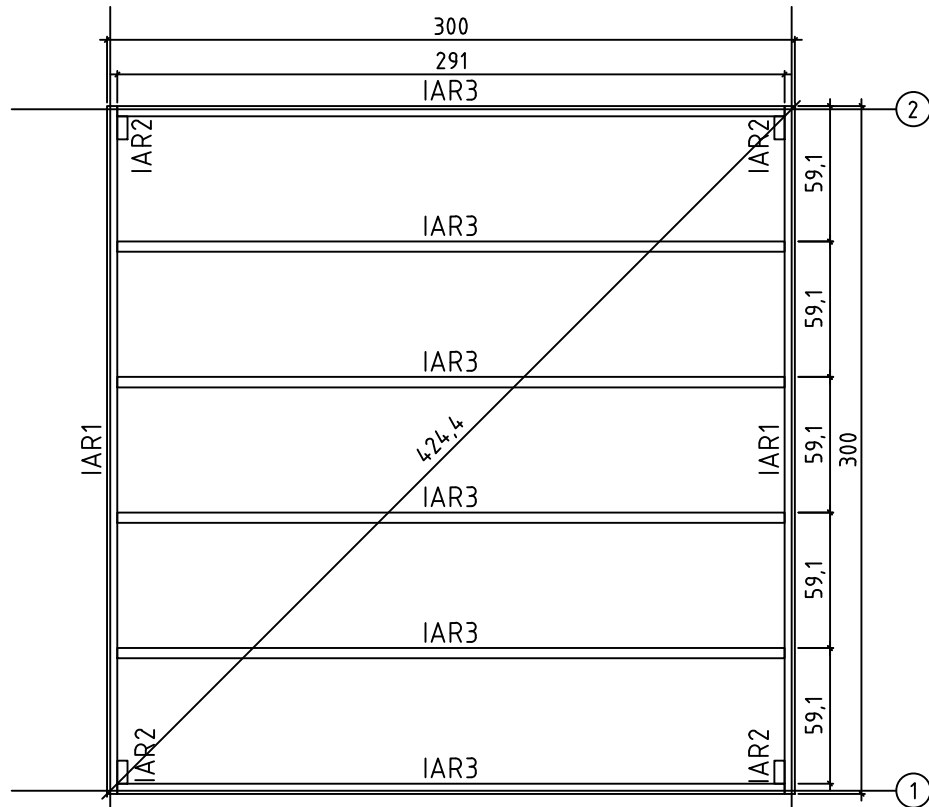

## Podlahová prkna

Floor boards - Fussbodenbretter - Plan pose plancher -  
Pavimento - Vloerhout - Põrandalaudis

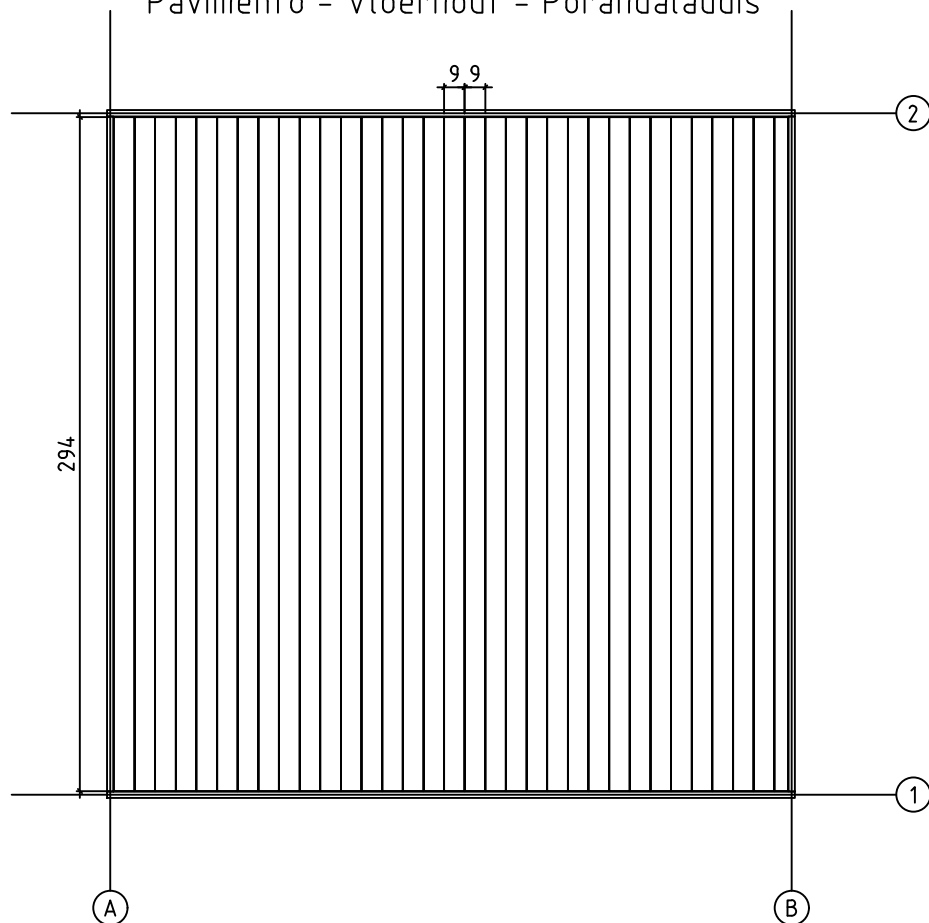

17.01.2023

3/23

# Art. Nr. 2853400

Bez pera Without tongue - Ohne feder - Madrier de finition -  
Finale in legno - Zonder veer - Punnita

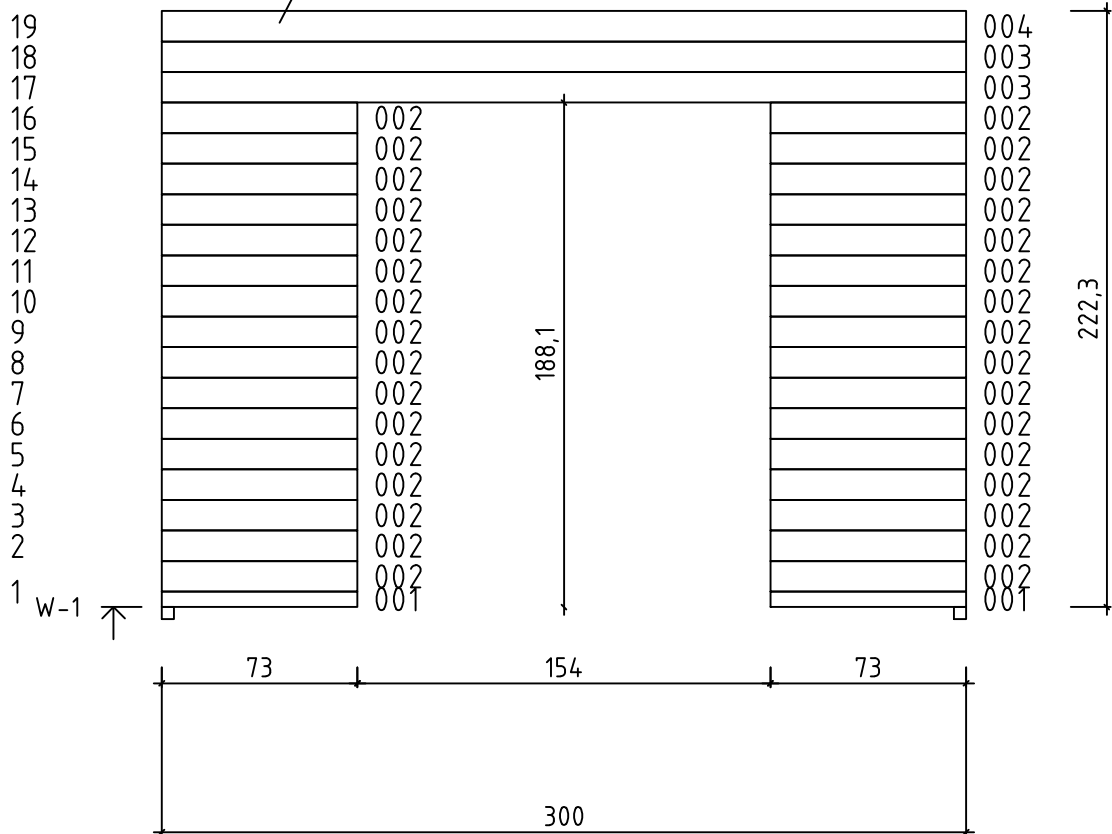

Bez pera Without tongue - Ohne feder - Madrier de finition -  
Finale in legno - Zonder veer - Punnita

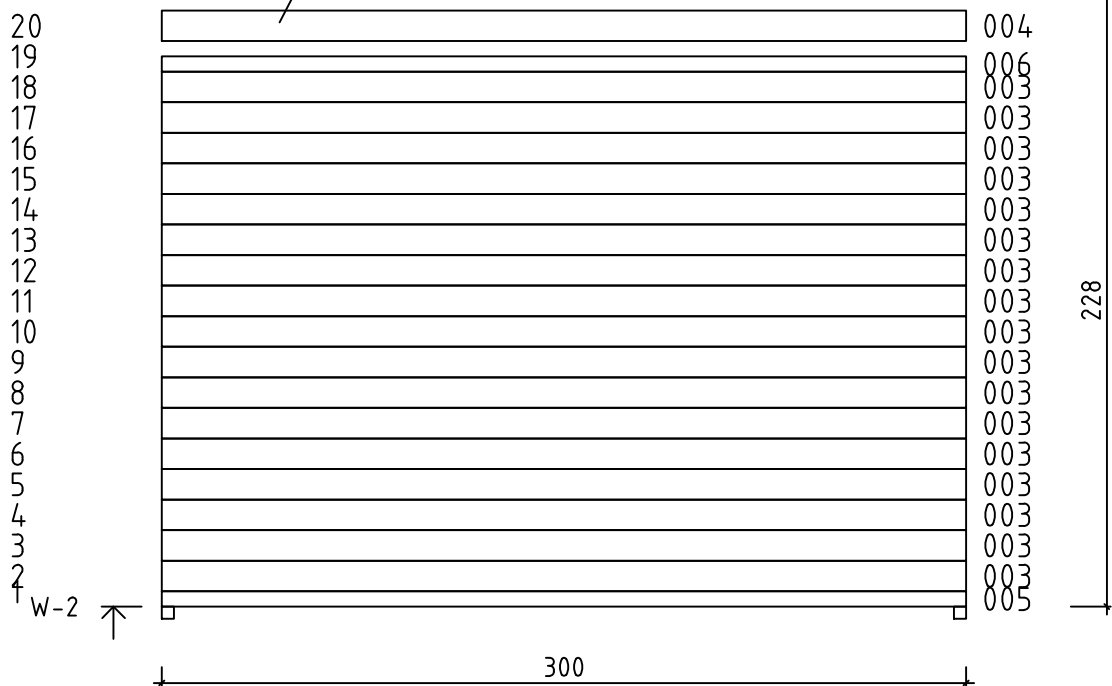





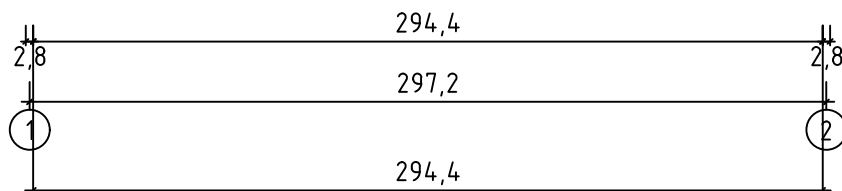
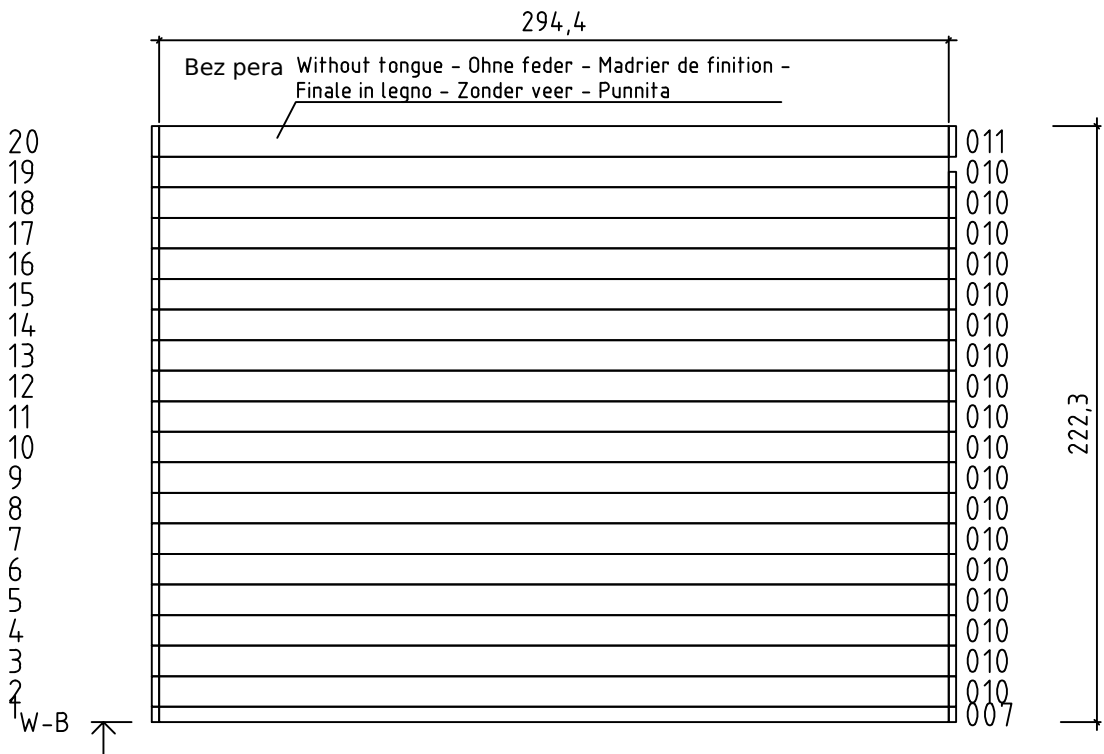
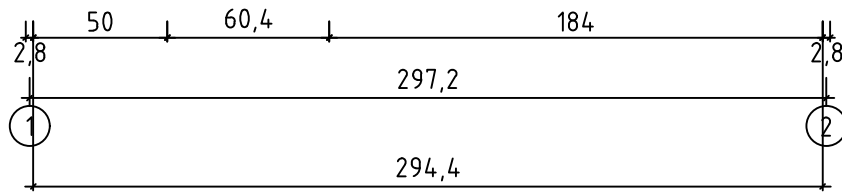
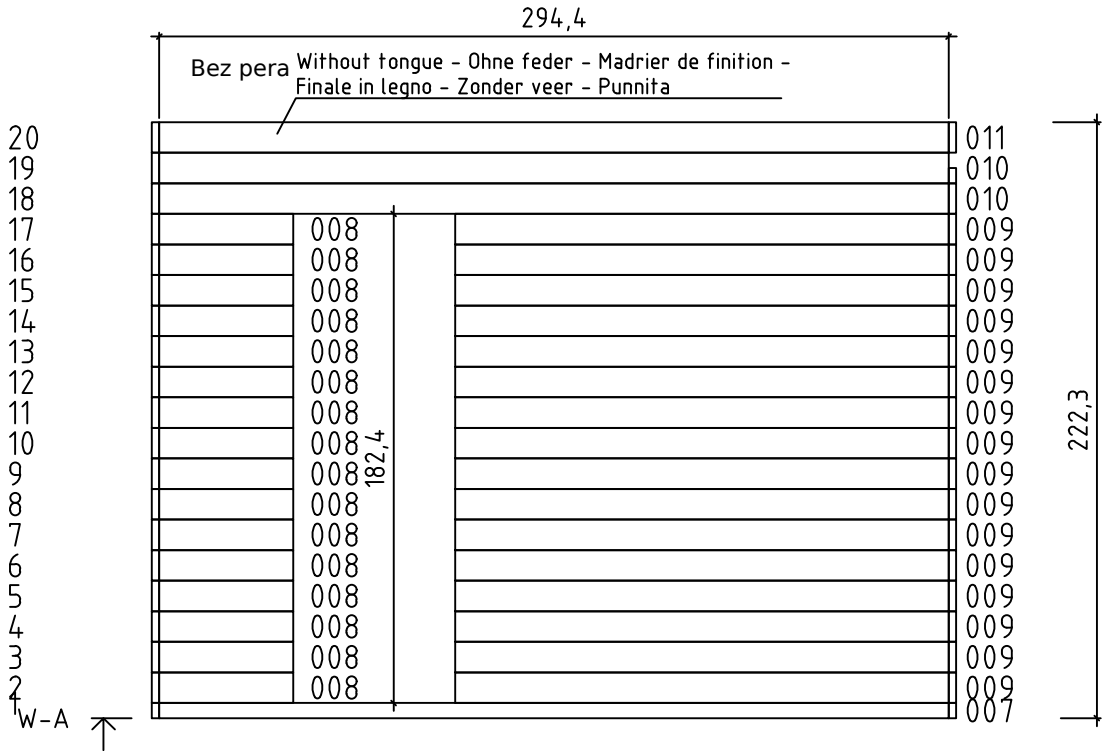

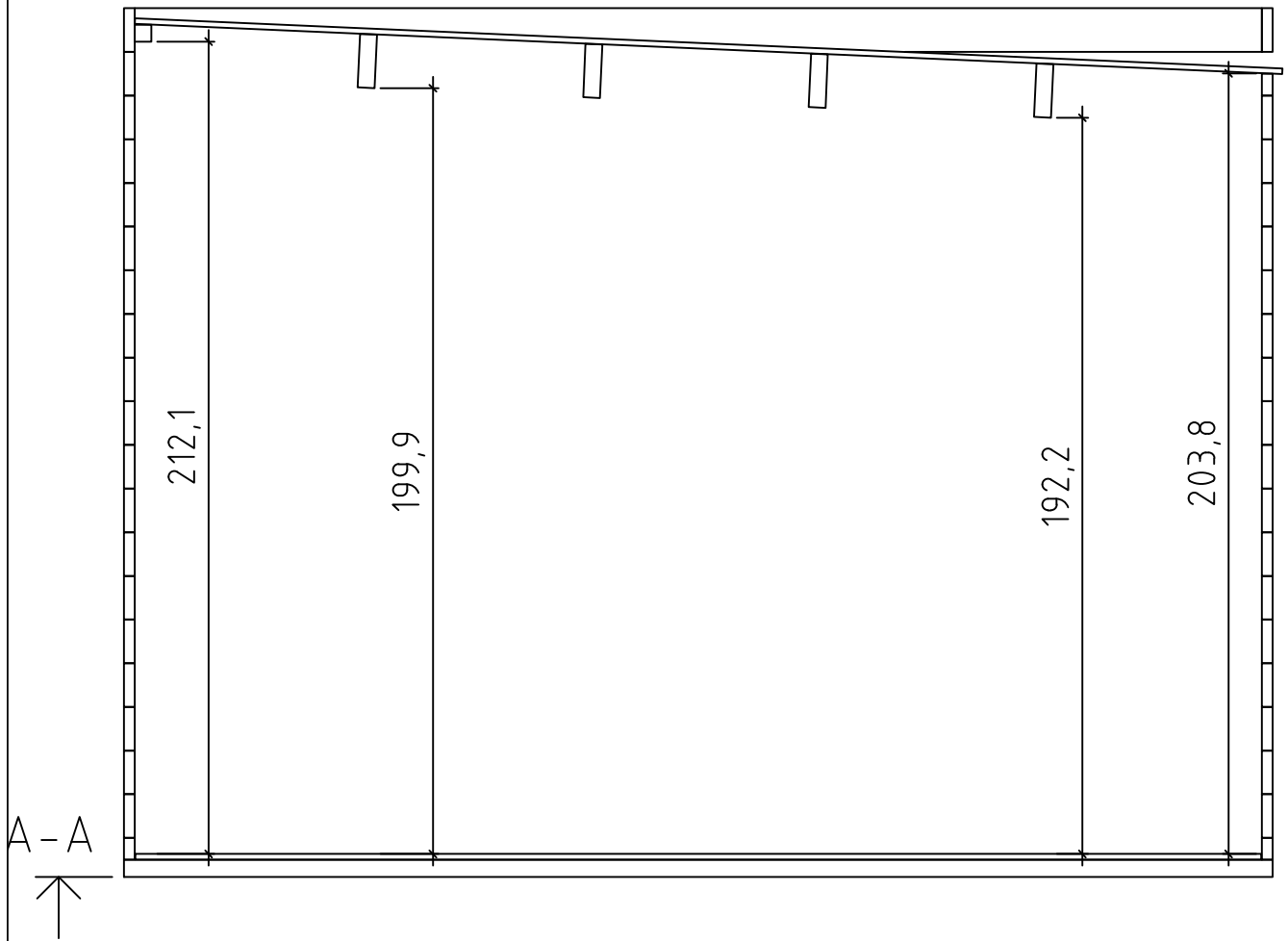

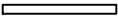

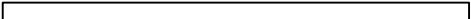

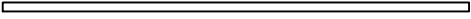
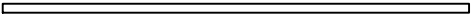

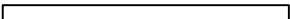
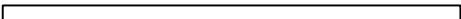
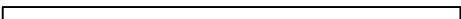

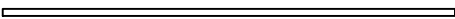

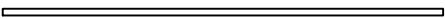

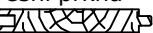

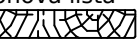

# Art. Nr. 2853400

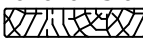
Výrobní číslo 2853400



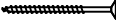
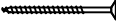
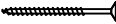
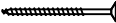
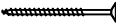
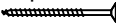
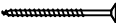
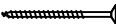
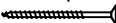

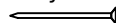
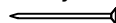
Pos	17.01.2023	Piece list - Stückliste - Liste des pièces - Elementi - Stuklijst - Tükítabel <b>Kusovník</b> Art. Nr. 2853400	7/21	Q	P (mm)	L (mm)
001 39986				2	28x57	730
002 13180				32	28x114	730
003 1021				19	28x114	3000
004 35770				2	28x114	3000
005 23513				1	28x57	3000
006 44377				1	28x57	3000
007 23530				2	28x57	2944
008 5690				16	28x114	500
009 41073				16	28x114	1840
010 18093				20	28x114	2944
011 44379				2	28x114	2944
IAR1 21752		Foundation - Fundament - Fondation - Fondamenta - Fundering - Immutatud alusraam	Základy	2	45x45	3000
IAR3 25553		Foundation - Fundament - Fondation - Fondamenta - Fundering - Immutatud alusraam	Základy	6	45x45	2910
IAR2 44380		Foundation - Fundament - Fondation - Fondamenta - Fundering - Immutatud alusraam	Základy	4	45x45	100
RV1 44709		Lath - Pfetten - Liteau - Piccola asse - Gordingen - Roov	Vaznice	2	44x44	2834
A-PR1 44710		Roof beam - Dachbalken - Panne de toit - Perlina del tetto - Gordingen / dakbalk - Pärlin	Střešní nosník	4	44x140	2936
FB 23056	Floor boards - Fussbodenbretter - Lame de plancher - Pavimento - Vloerhout - Põrandalaud		Podlahová prkna	33	90x15	2940
RB 33576	Roof boards - Dachbretter - Voliges - Perlina per tetto - Dakhout - Katuselaud		Střešní prkna	33	90x15	3000
30087	Floor fillet - Fussbodenteiste - Corniere de finition du plancher - Finitura per pavimento (battisco pa) - Vloerafwerkljst - Põrandaliist		Podlahová lišta		18x18	13
P1 44712	Post - Pfosten - Poteau - Piede registrabile - Stijl - Post		Sloupky	2	55x55	2050
P2 44713	Post - Pfosten - Poteau - Piede registrabile - Stijl - Post		Sloupky	2	55x55	2180
CF1 41365	Corner fillet - Deckleiste - Profils de finition angles a l'exterieur - Massello d'angolo - (hoek)lijst - Nurgaliist		Rohová lišta	4	15x70	2223
CF2 23609	Corner fillet - Deckleiste - Profils de finition angles a l'exterieur - Massello d'angolo - (hoek)lijst - Nurgaliist		Rohová lišta	2	15x90	2052

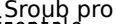
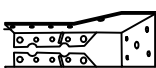
Pos	17.01.2023	Piece list - Stückliste - Liste des pièces - Elementi - Stuklijst - Tükítabel <b>Kusovník</b> Art. Nr. 2853400	8/21	Q	P (mm)	L (mm)
CF3 44711	Corner fillet - Deckleiste - Profils de finition angles a l'exterieur - Massello d'angolo - (hoek)lijst - Nurgaliist	Rohová lišta 		2	15x90	2223
44727	Fascia sheet - Abschlussprofil - Profil de finition métallique pour débord de toiture - Scossalina di protezione dall'acqua per bordo di legno - Afdek profiel / boordprofiel - Räästaplekk	Ukončovací profil 		4		2900
FF1 43853	Fixing fillet - Fixierungsleiste - Profil de fixation - Massello di fissaggio - Bevestiging lijstwerk - Tenderliist	Fixační lišta 		2	18x28	1800
FF2 23522	Fixing fillet - Fixierungsleiste - Profil de fixation - Massello di fissaggio - Bevestiging lijstwerk - Tenderliist	Fixační lišta 		2	18x28	1850
HS4 5102	Screw for corner fillet - Schraube zur befestigung deckleiste - Vis pour profils de finition angles a l'exterieur - Viti per massellino d'angolo - Schroef voor afdekljst (hoek) - Krugi nurgaliistule	Šroub pro rohovou lištu 		40	3x30	
HS12 5109	Screw for beam holder - Schrauben für balkenhalter - Vis de fixation support "u" galvanisé - Vite per trave di sostegno - Schroef voor bevestiging balkhouder (gordingschoen) - Krugi talakingale	Šroub pro držák nosníku 		48	4x40	
HS12 5109	Screw for fixing fillet of door and window - Schrauben für fixierungsleiste - Vis pour profil vertical de fixation pour ouvertures des fenetres et portes - Viti per massello di fissaggio - Schroeven voor bevestiging van deur en raam lijsten - Krugi tenderliistudele	Šroub pro fixační lištu dveří a oken 		66	4x40	
HS13 5110	Screw for wall details - Schraube für wand details - Vis pour mur details - Viti per elementi della porta - Schroef voor wand details - Krugi seinadetailile	Šroub pro stěnové detaily 		320	4x60	
HS27	Screw for roof lath - Schraube für dachlatte - Vis pour latte - Vite per listello del tetto - Schroef voor daklat - Krugi roovile	Šroub pro střešní lišty 		7	5x70	
HS16 5115	Screw for 1. wall beam - Schraube für 1. bohlenreihe - Vis de fixations 1ere rangée de madriers avec poutrelles de fondations - Vite fissaggio alle fondamenta - Schroef voor 1 wandbalk - Krugi poolaualae	Šroub pro 1. řadu stěny 		16	5x90	
HS16 5115	Screw for foundation - Schrauben zur befestigung fundament - Vis de fixations des poutrelles de fondations - Viti x fondamenta - Schroef voor fundering - Krugi alusraamile	Šroub pro základy 		16	5x90	
HS23 5121	Screw for wall details - Schraube für wand details - Vis pour mur details - Viti per elementi della porta - Schroef voor wand details - Krugi seinadetailidele	Šroub pro stěnové detaily 		12	6x180	
HS29	Screw for beam holder - Schrauben für balkenhalter - Vis de fixation support "u" galvanisé - Vite per trave di sostegno - Schroef voor bevestiging balkhouder (gordingschoen) - Krugi talakingale	Šroub pro držák nosníku 		64	5x25	
NF2 5127	Zn nail for floor fillet - Zn nagel für fussbodenleiste - Pointe pour corniere de finition du plancher - Chiodi x fissaggio pavimento - Spijker(nagel) voor vloer afdekljst - Nael põrandaliistule	Zinkový hřebík pro podlahovou lištu 		26	1.4x40	
NF4 5137	Zn nail for roof - Zn nagel für dachbretter - Pointe pour fixation voliges de toit - Chiodi x perline tetto - Spijker(nagel) voor dakhout - Nael katuselauale	Zinkový hřebík pro střechu 		210	2x50	
NF4 5137	Zn nail for floor - Zn nagel für fussbodenbretter - Clous pour plancher - Chiodi x perline pavimento - Spijker(nagel) voor vloer - Nael põrandalauale	Zinkový hřebík pro podlahu 		210	2x50	
44397	Fascia sheet corner - Eckprofil - Profil d'habillage de rives - Scossalina di protezione dall'acqua per angolo di borbo in legno - Hoekprofiel - Räästapleki nurk	Rohový profil 		4		
HS28 38555	Screw for fascia sheet - Schraube für blende vis pour fascia - vite per lamiera frontale - Schroef voor boeiplaat - Krugi räästaplekiile	Šroub pro upevnění okapové desky 		50	4.8x32	
BM 37607	Beam holder - Balkenhalter - Support en u galvanisé - Supporto della trave Balkendrager (gording schoen) - Talaking			8	Držák nosníku 45x137	
43186	Window - Fenster - Fenetre - Finestra - Raam - Aken	Okno 560x1780 AK.1.100.SSV SGC		1		
34282	Door - Tür - Porte - Porte - Deur - Uks	Dveře 1494x1850 TUK.1.100.SVV.MMc		1		



Art. Nr. 2853400

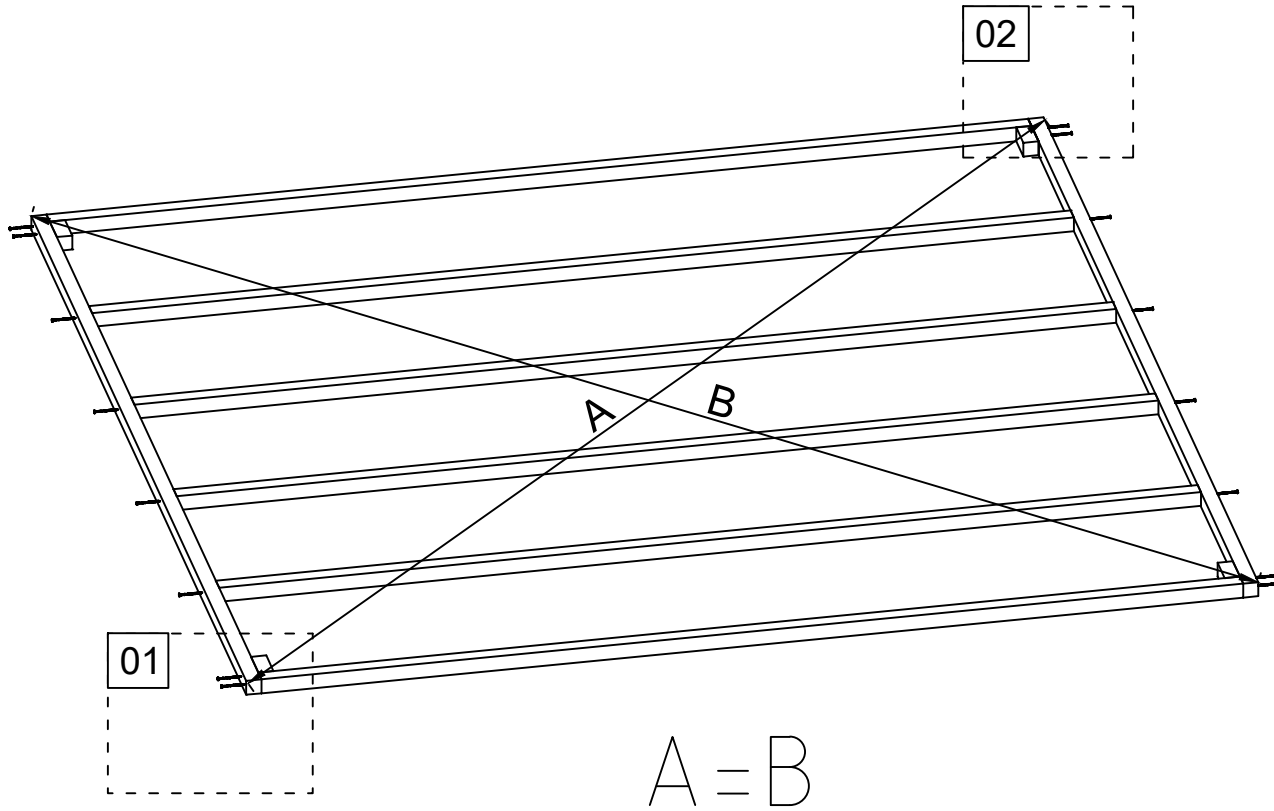

17.01.2023

01

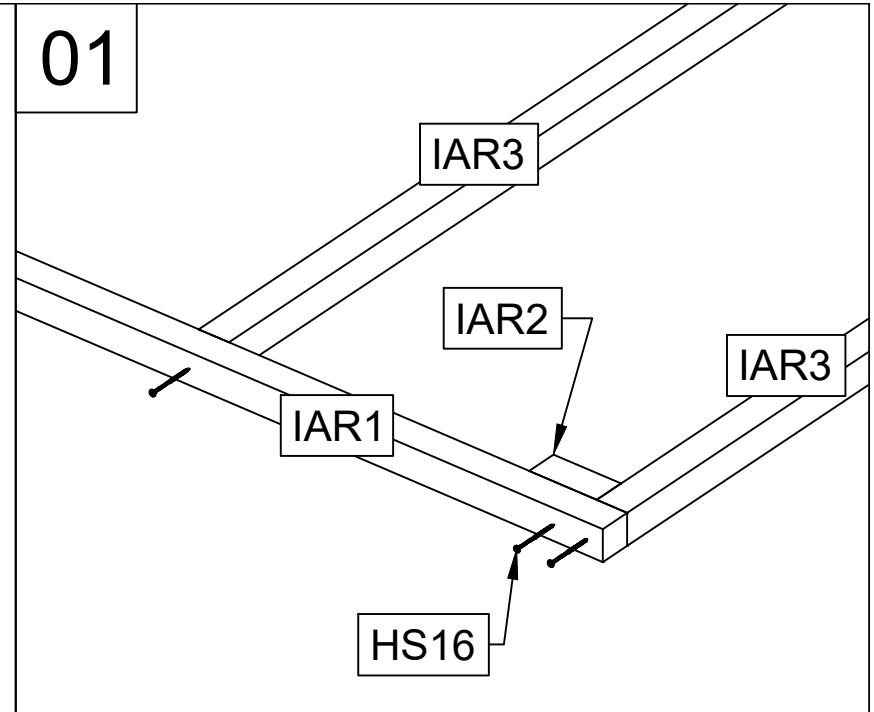

02

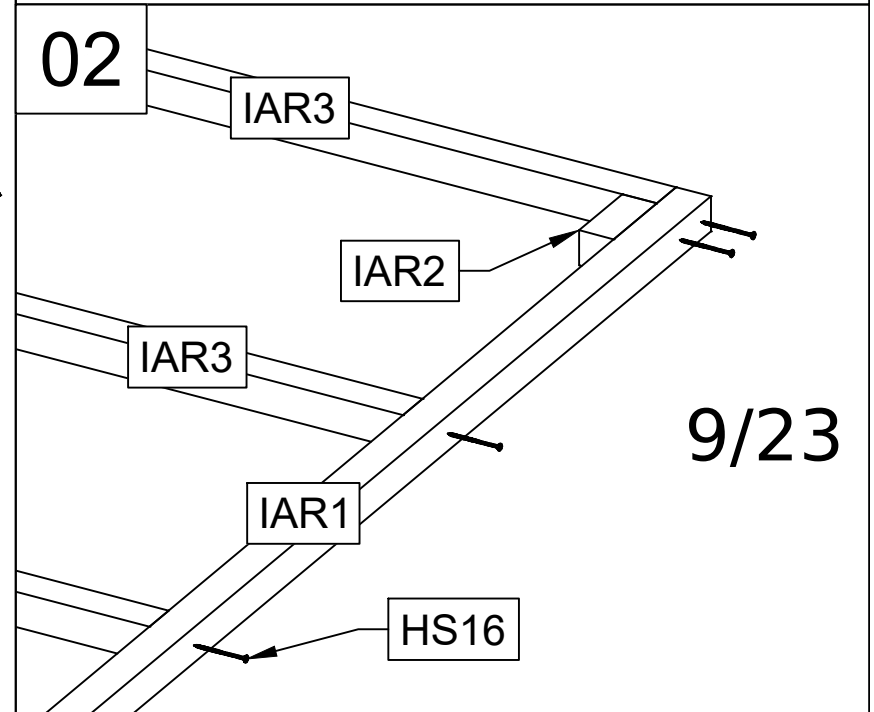

9/23

Art. Nr. 2853400

03

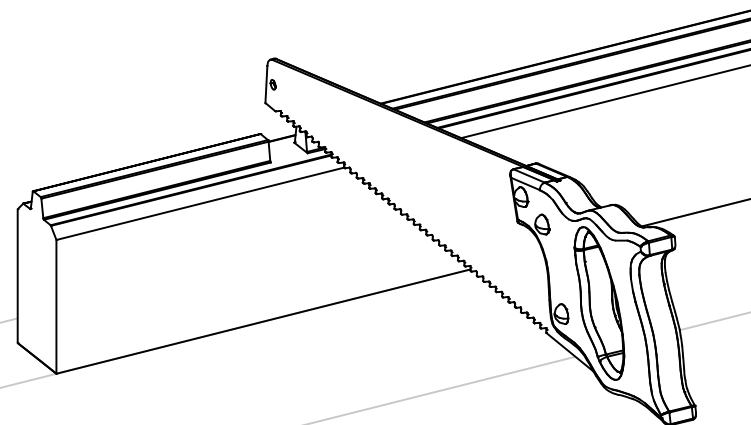
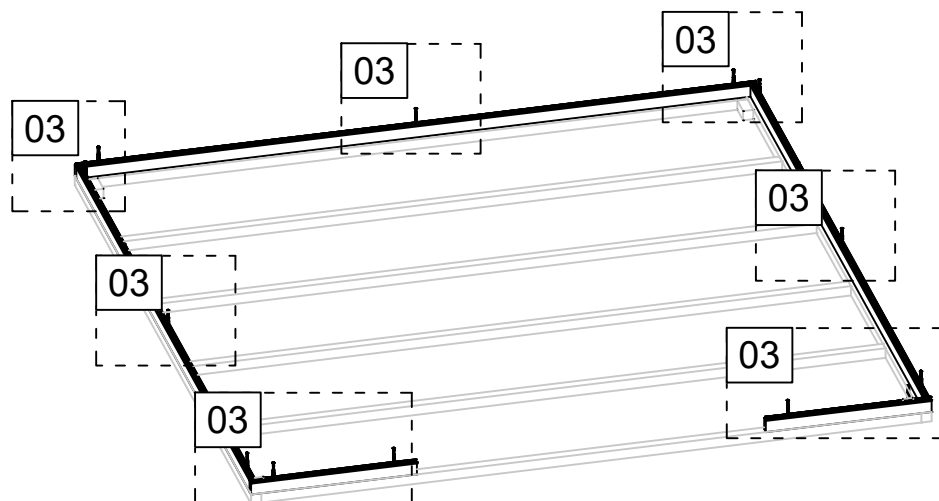

03

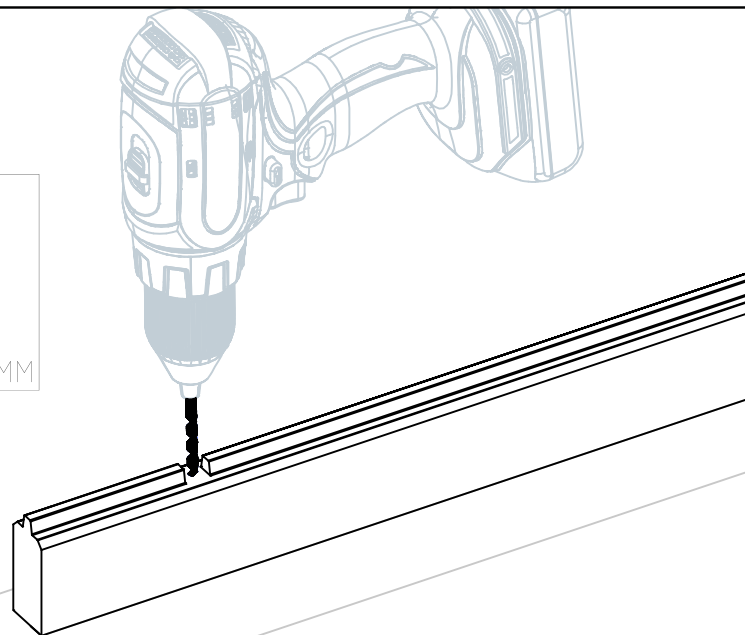
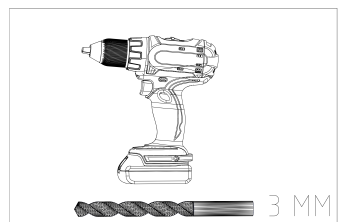

03

HS16

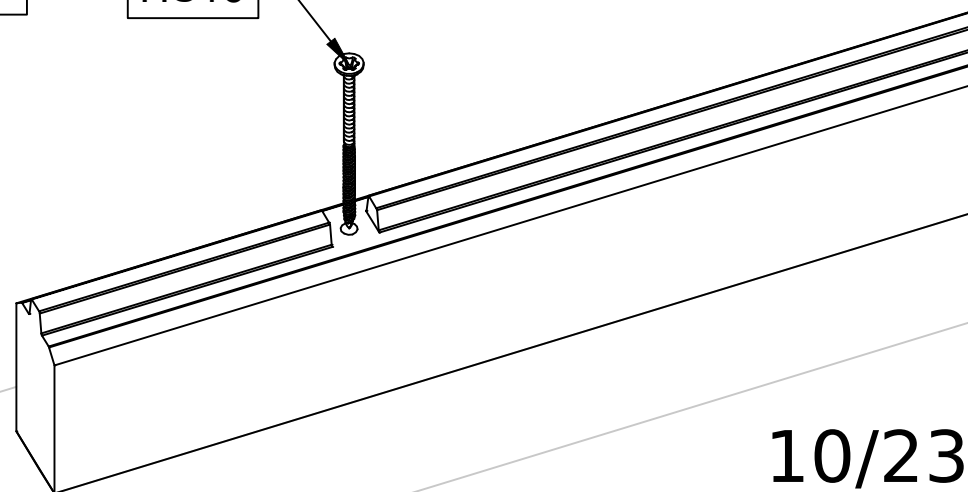

10/23

Art. Nr. 2853400

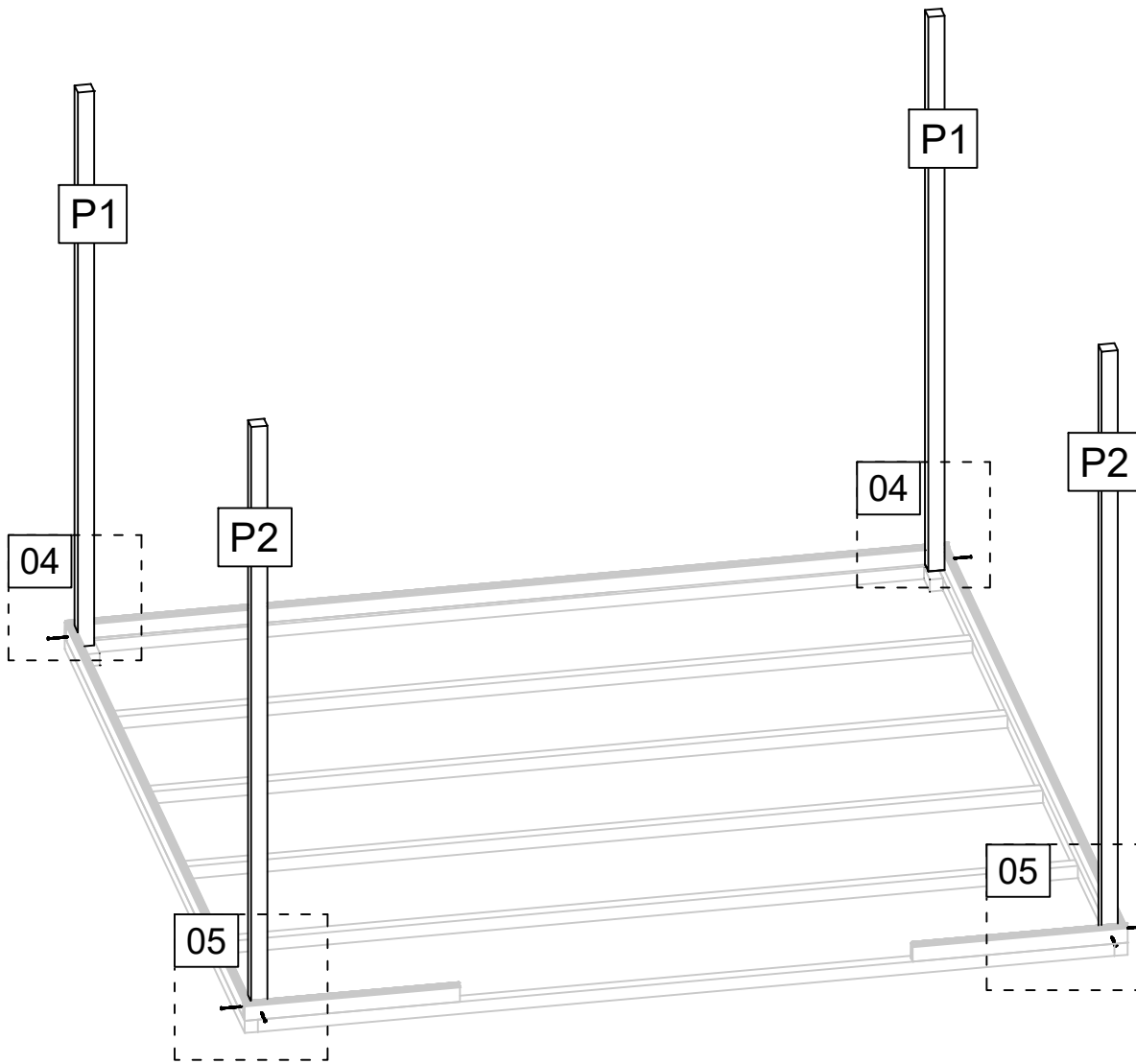

04

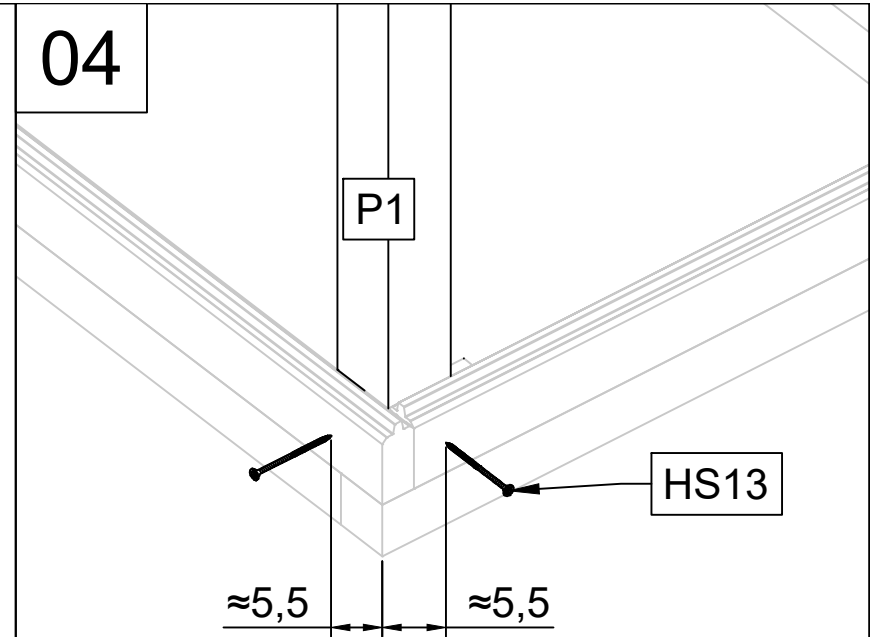

05

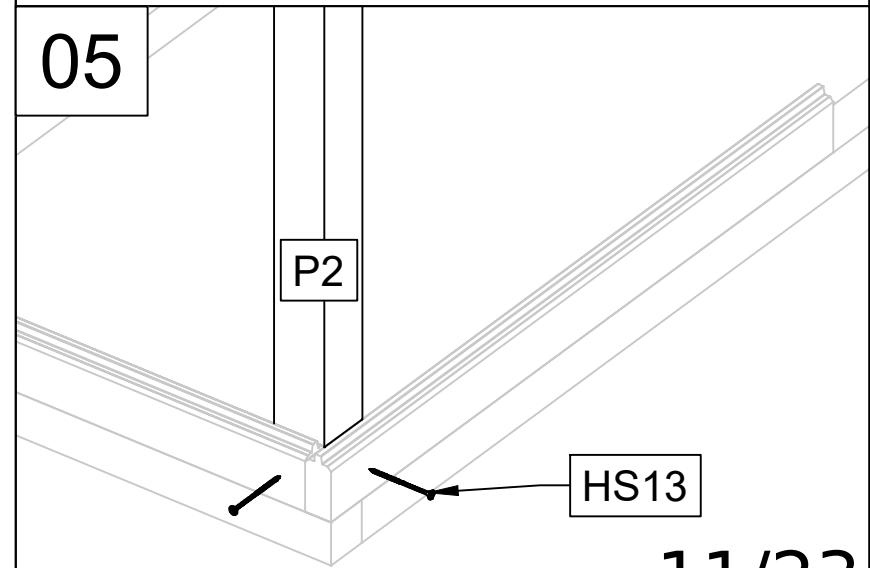

Art. Nr. 2853400

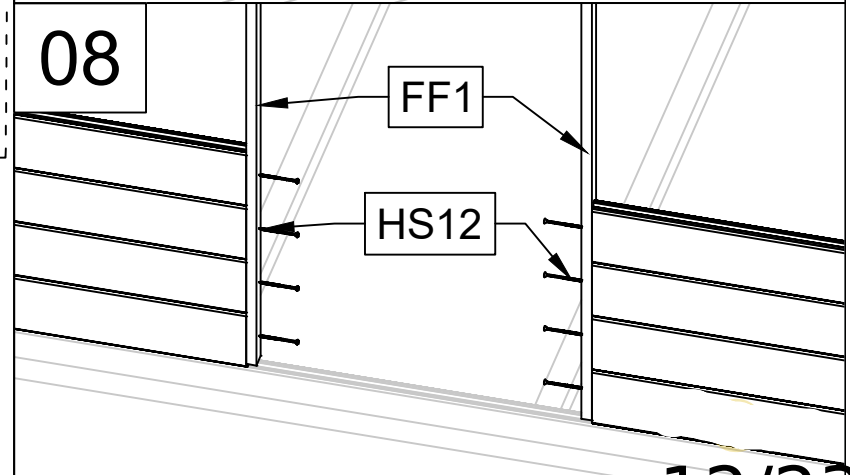
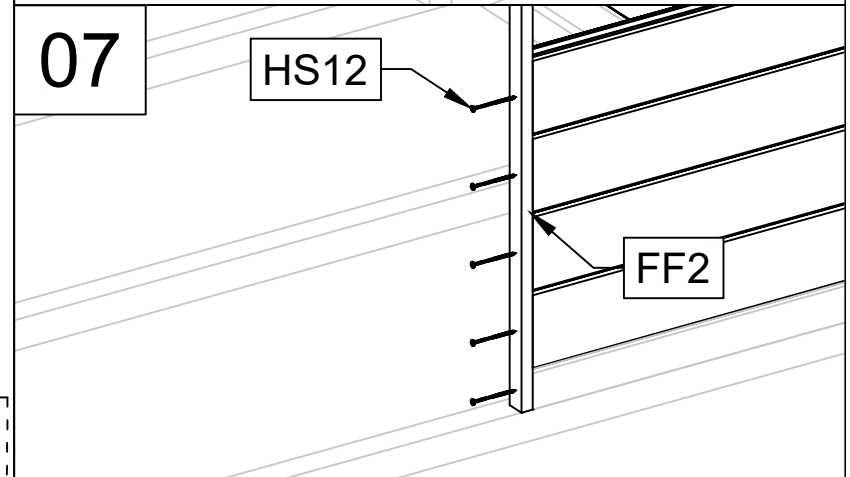
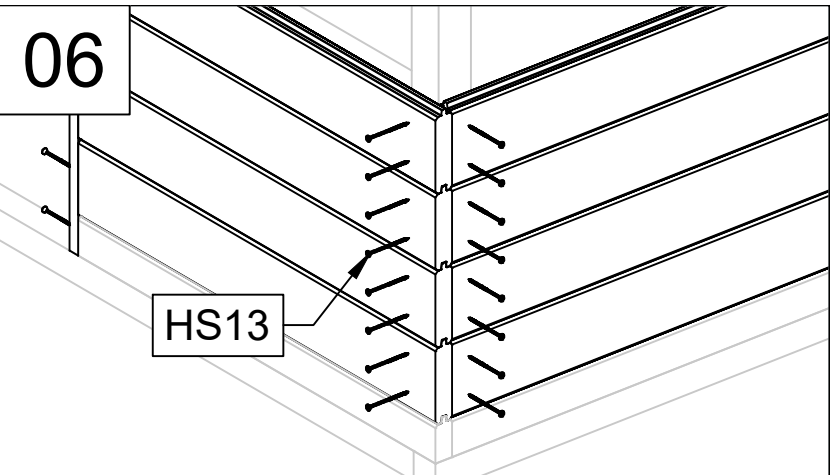
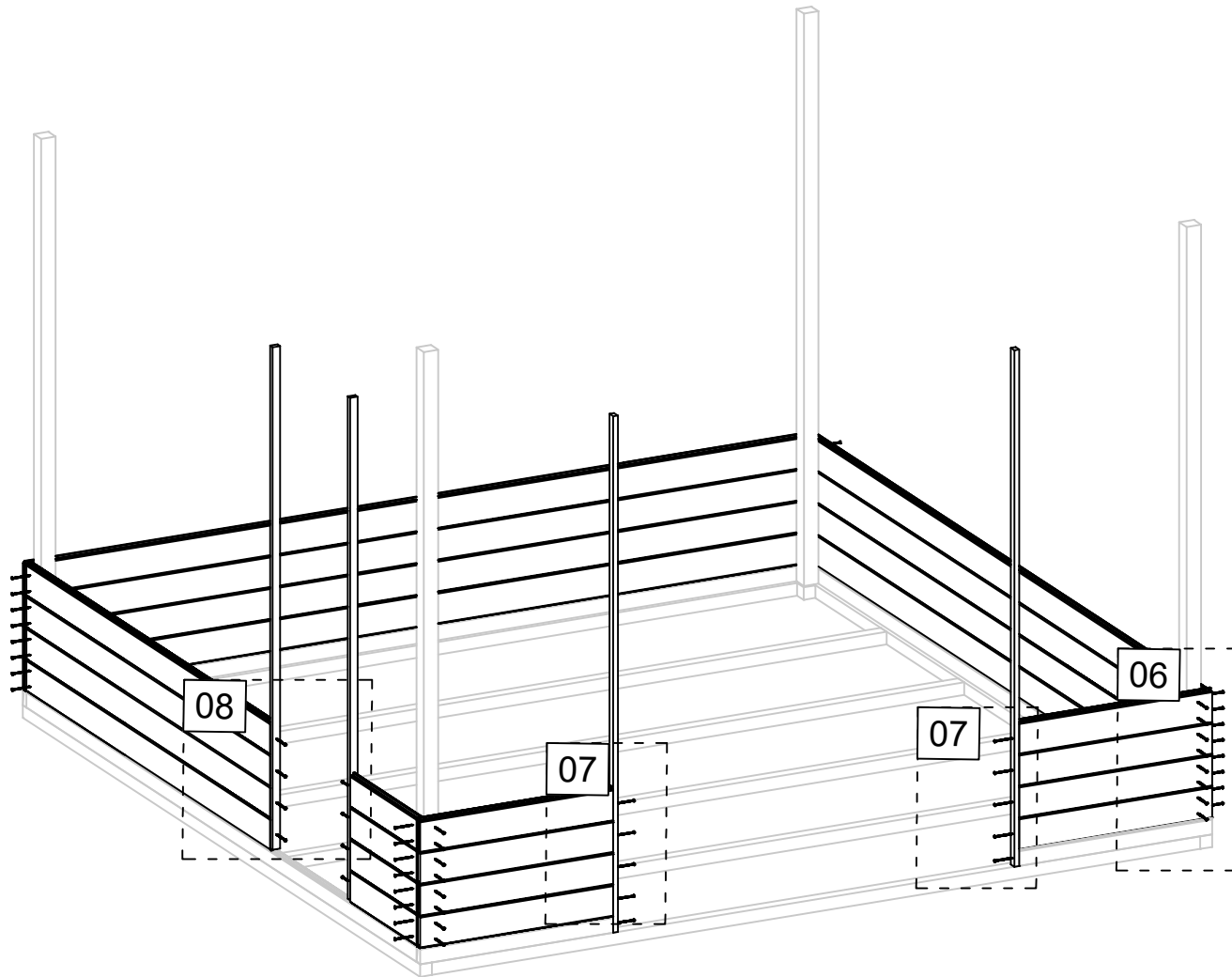

17.01.2023

Art. Nr. 2853400

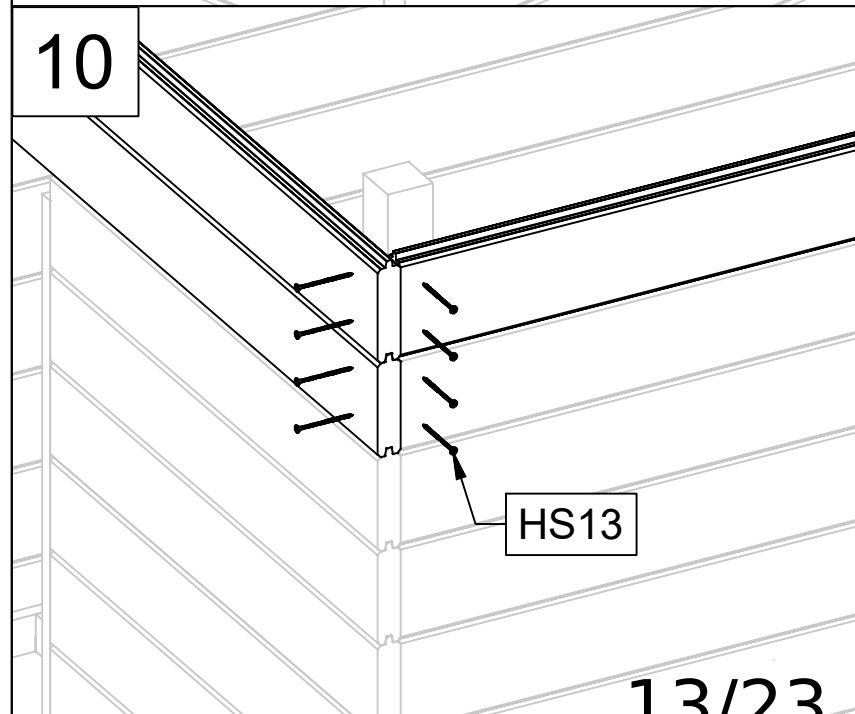
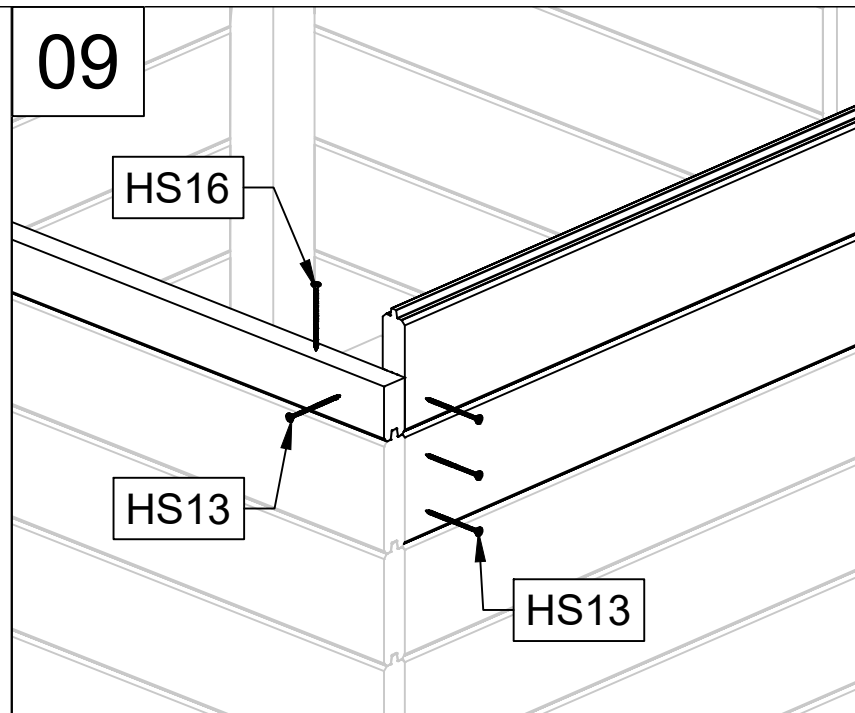
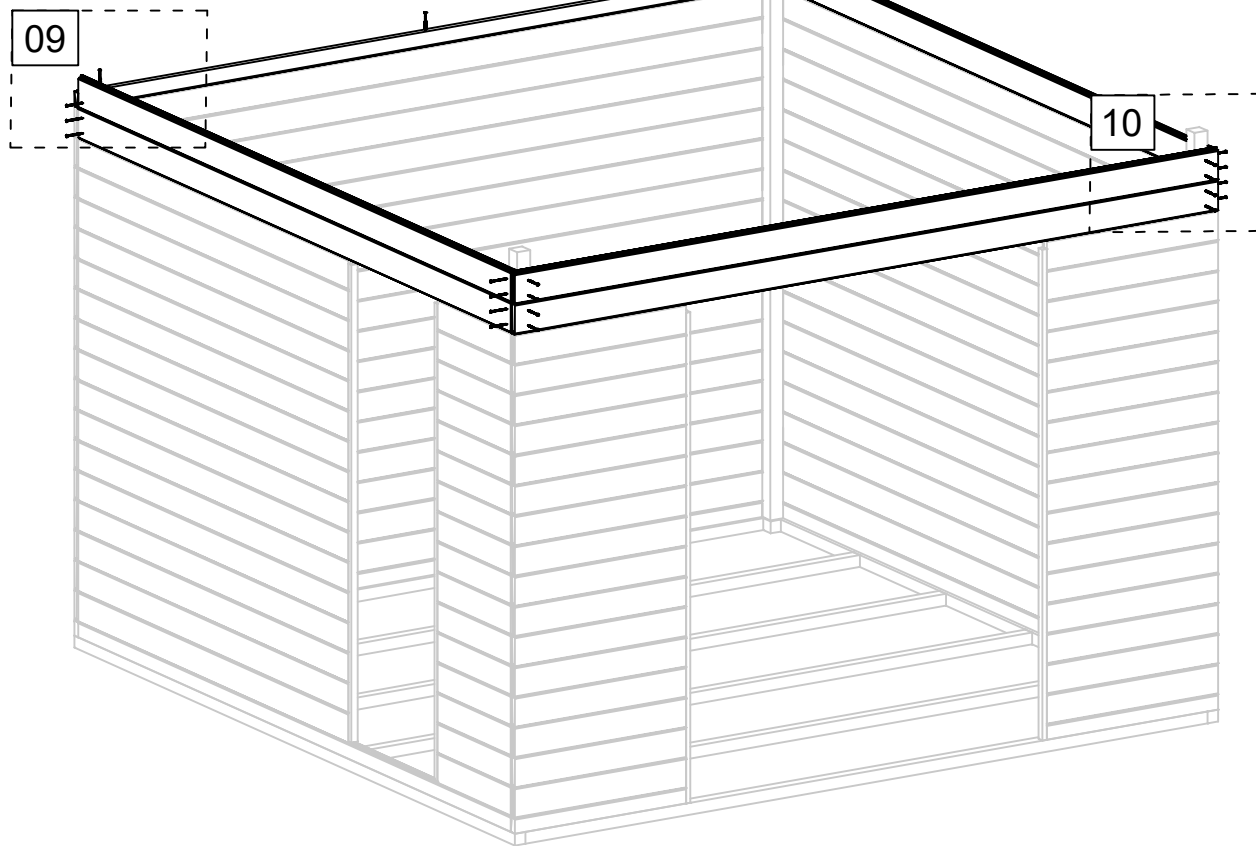

17.01.2023

13/23

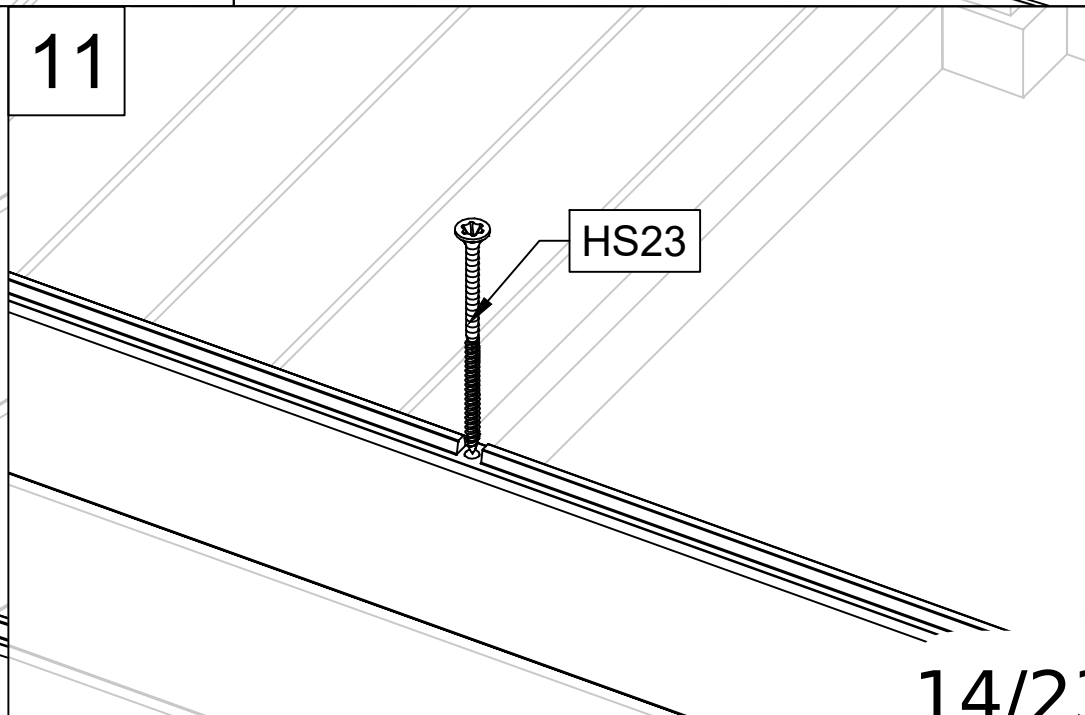
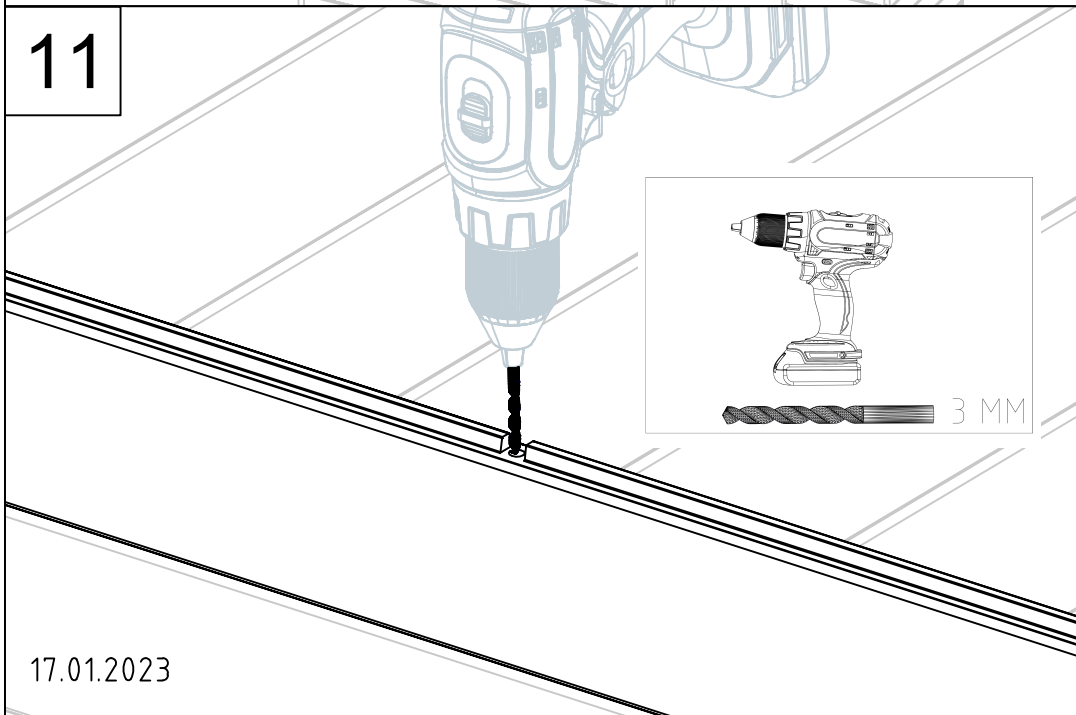
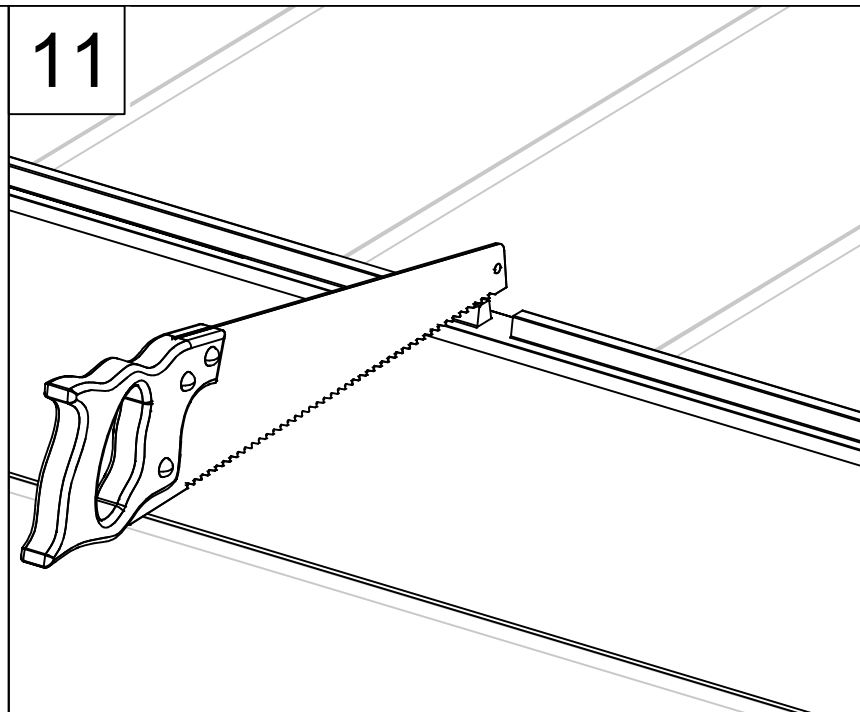
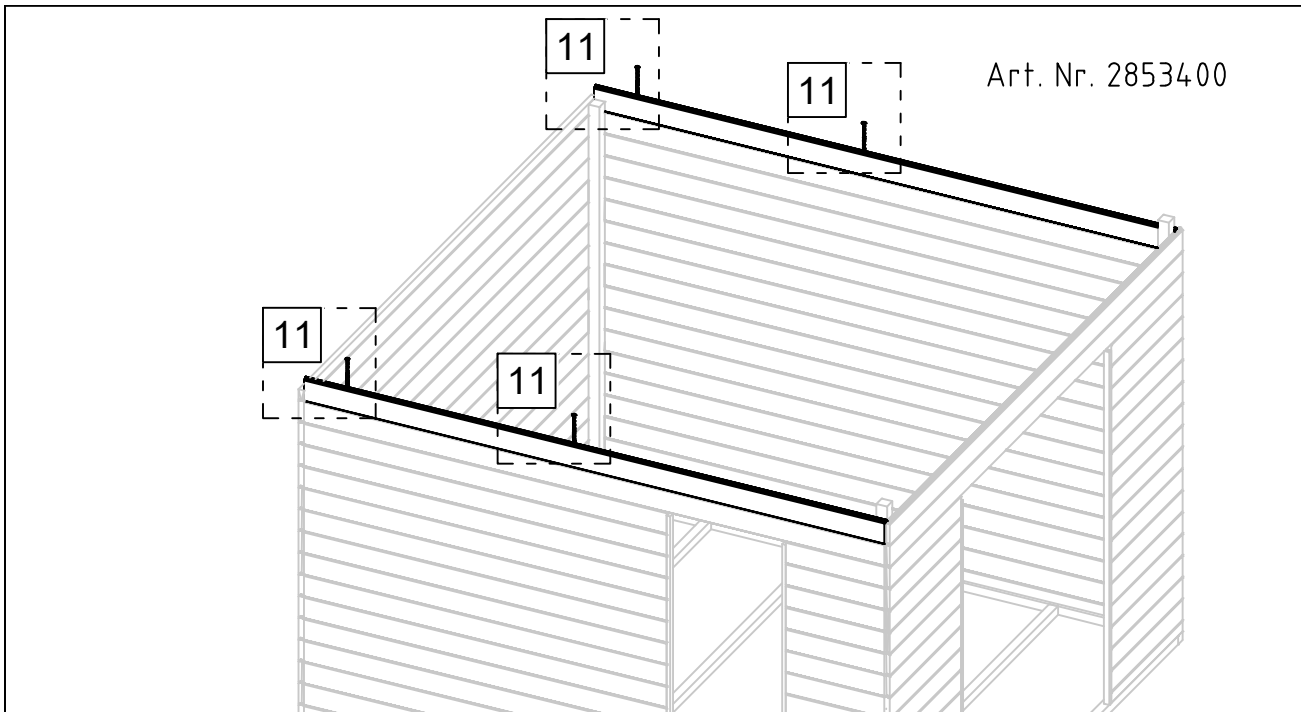

Art. Nr. 2853400

12

13

13

13

13

13

13

13

12

HS13

HS13

13

13

HS23

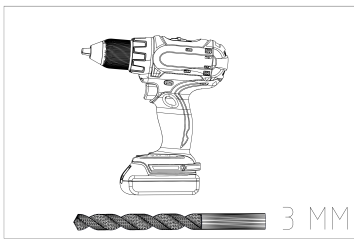

Art. Nr. 2853400

14



14

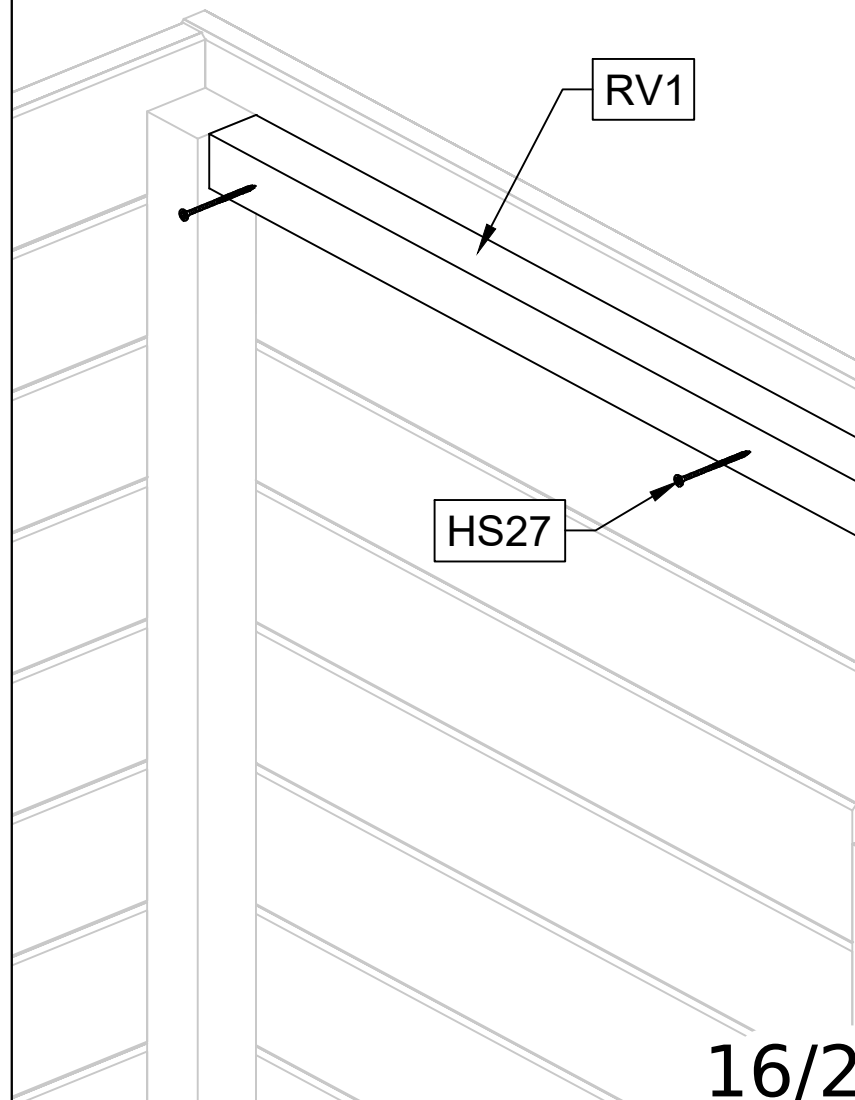

17.01.2023

16/23



Art. Nr. 28534.00

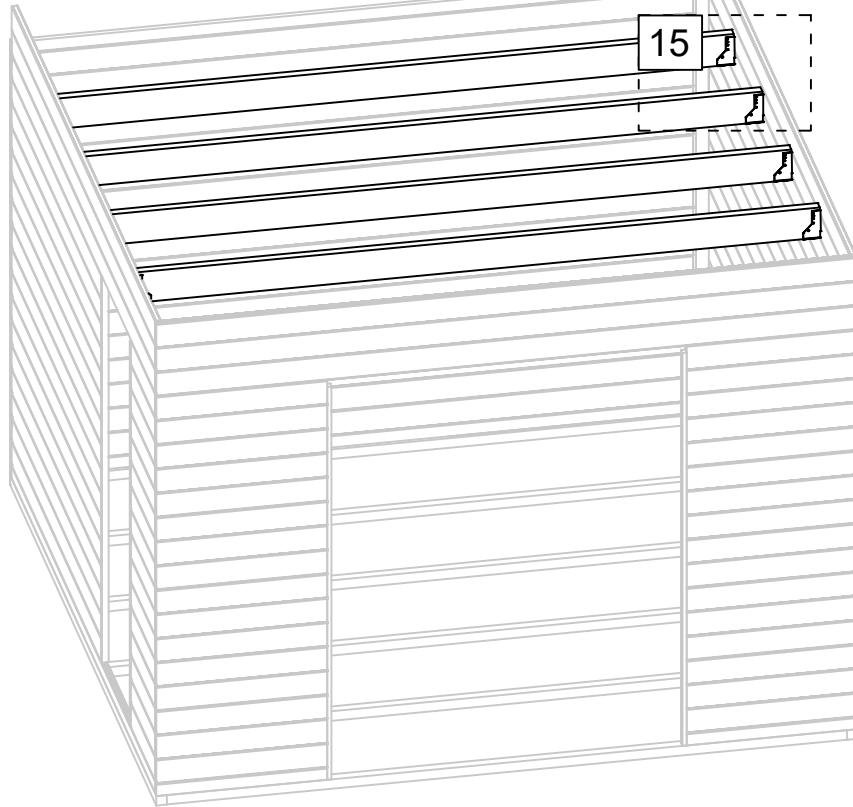

15

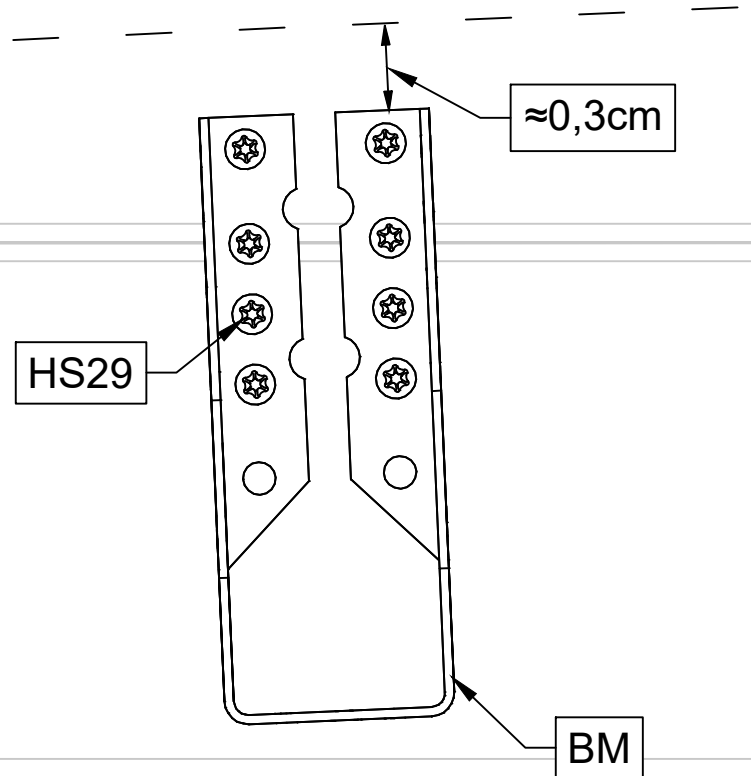

15

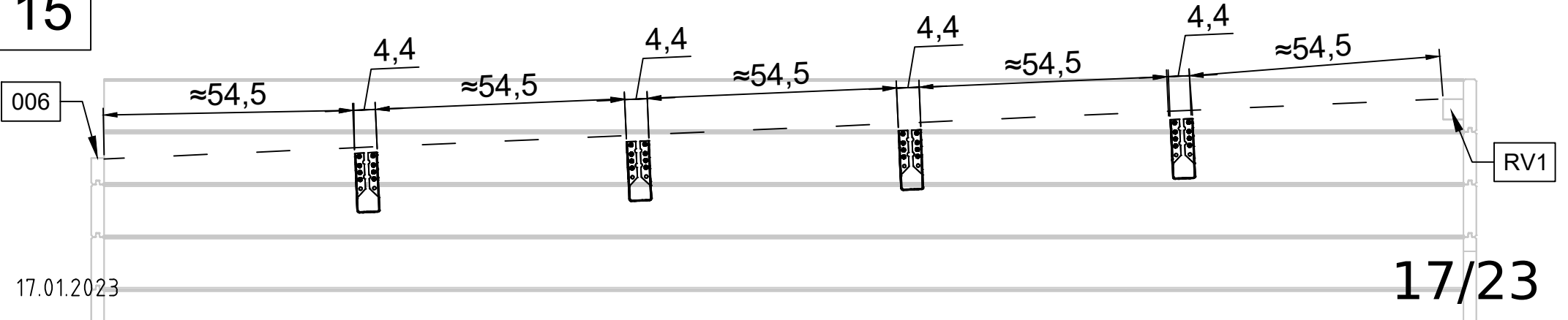

17.01.2023

17/23

Art. Nr. 2853400

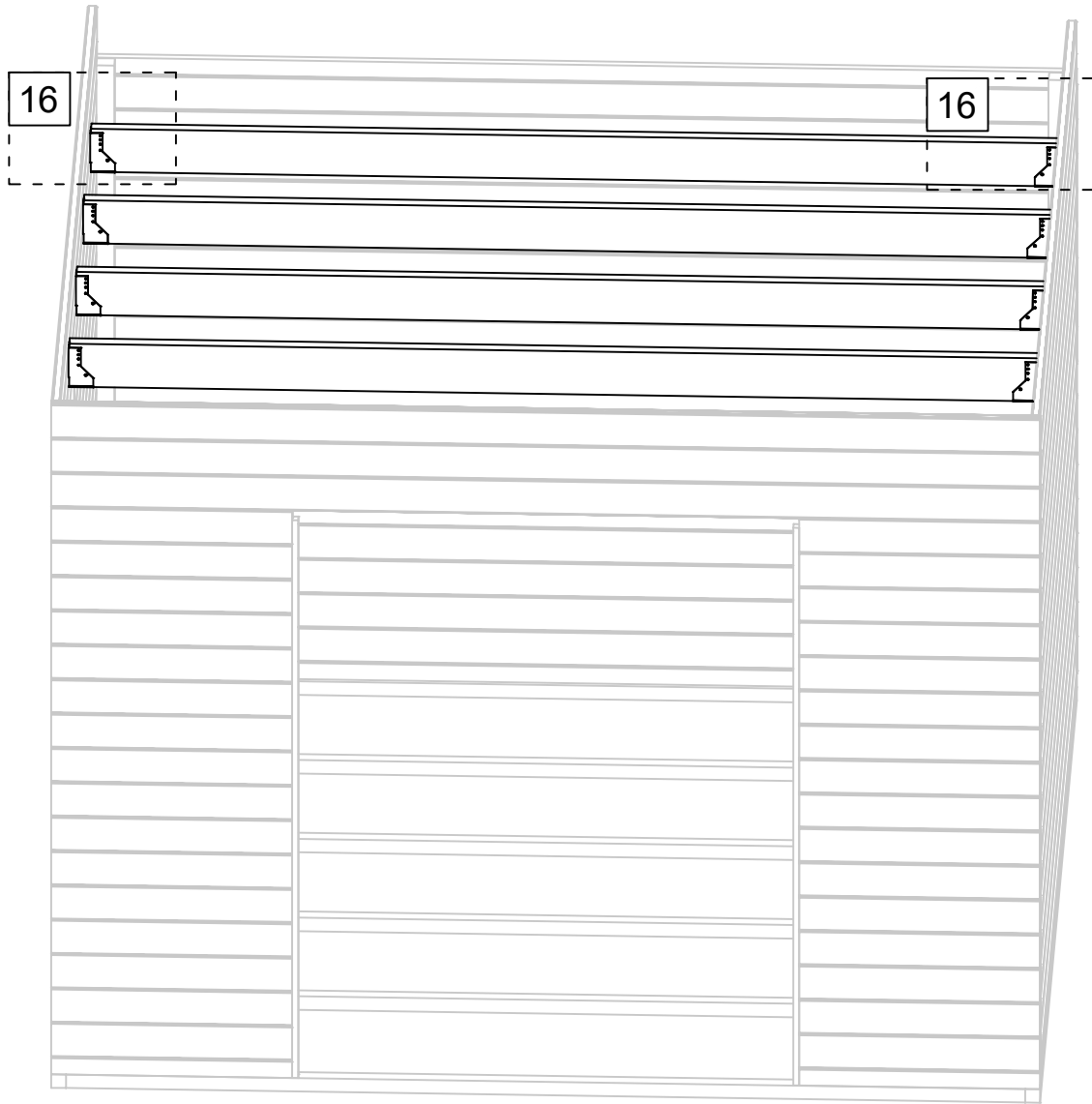

17.01.2023

16

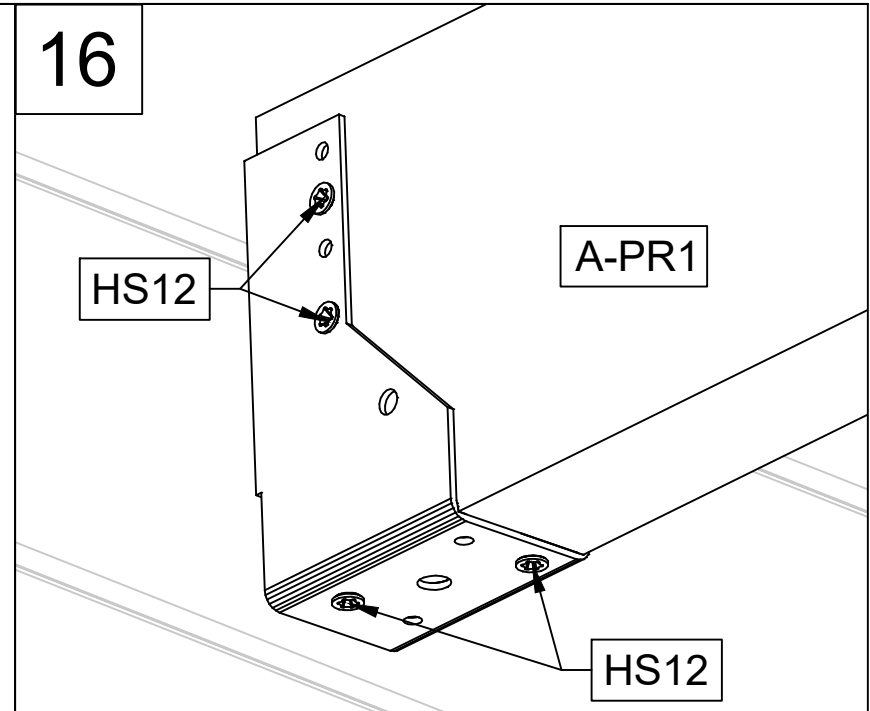

16

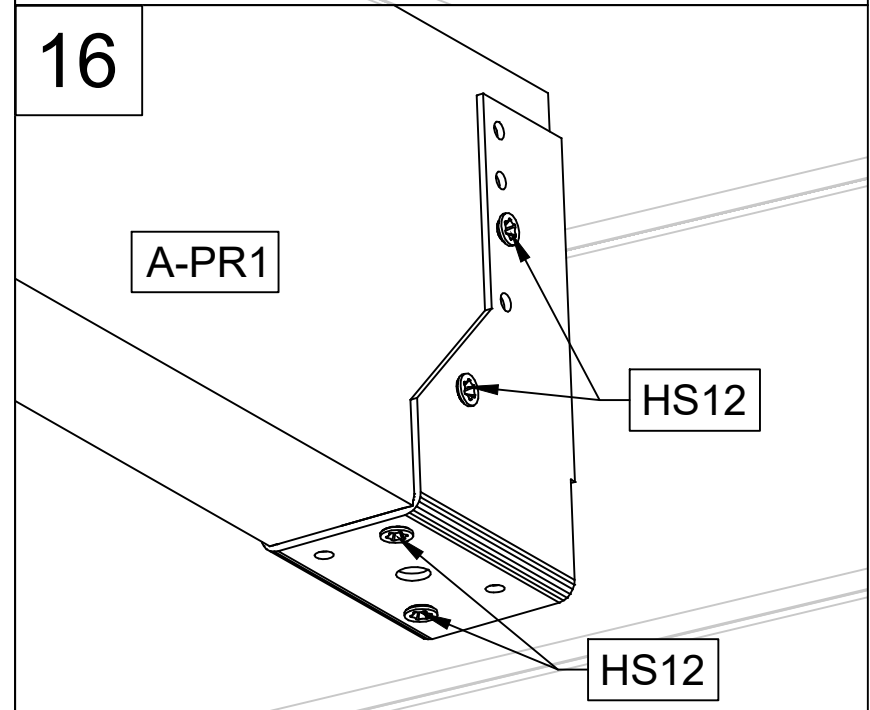

Art. Nr. 2853400

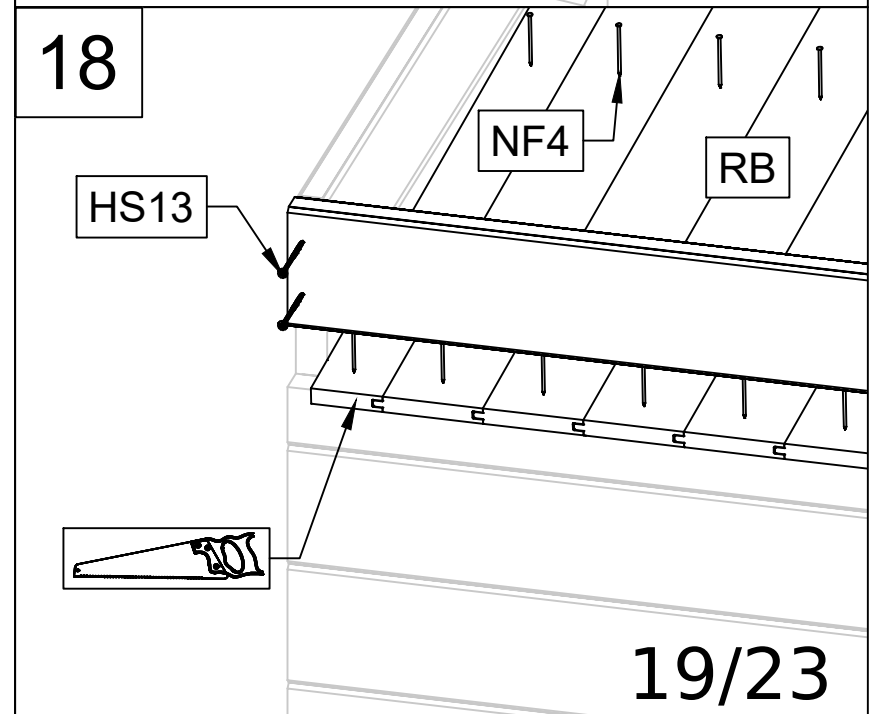
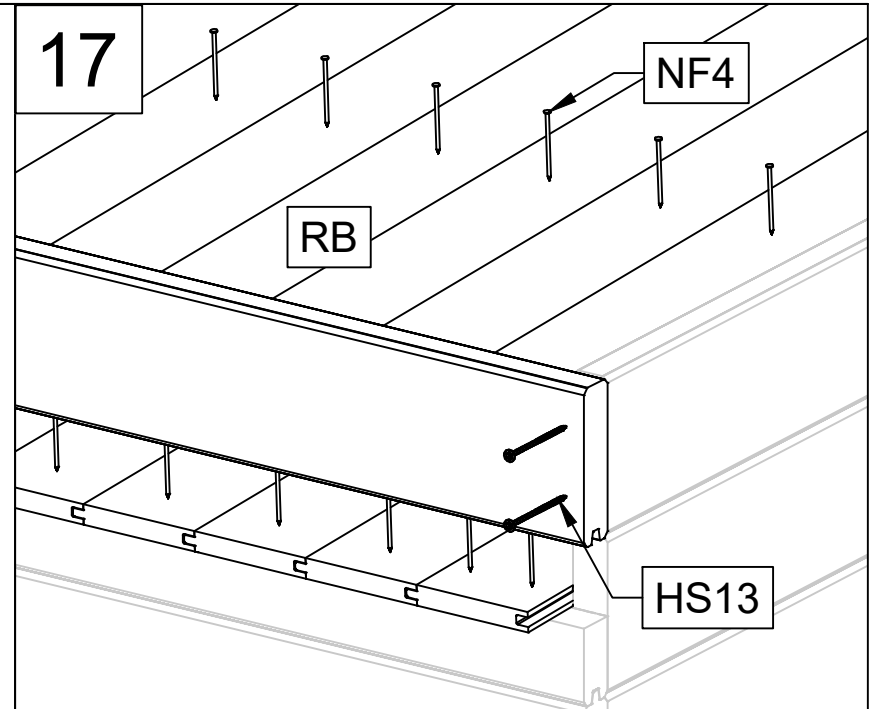
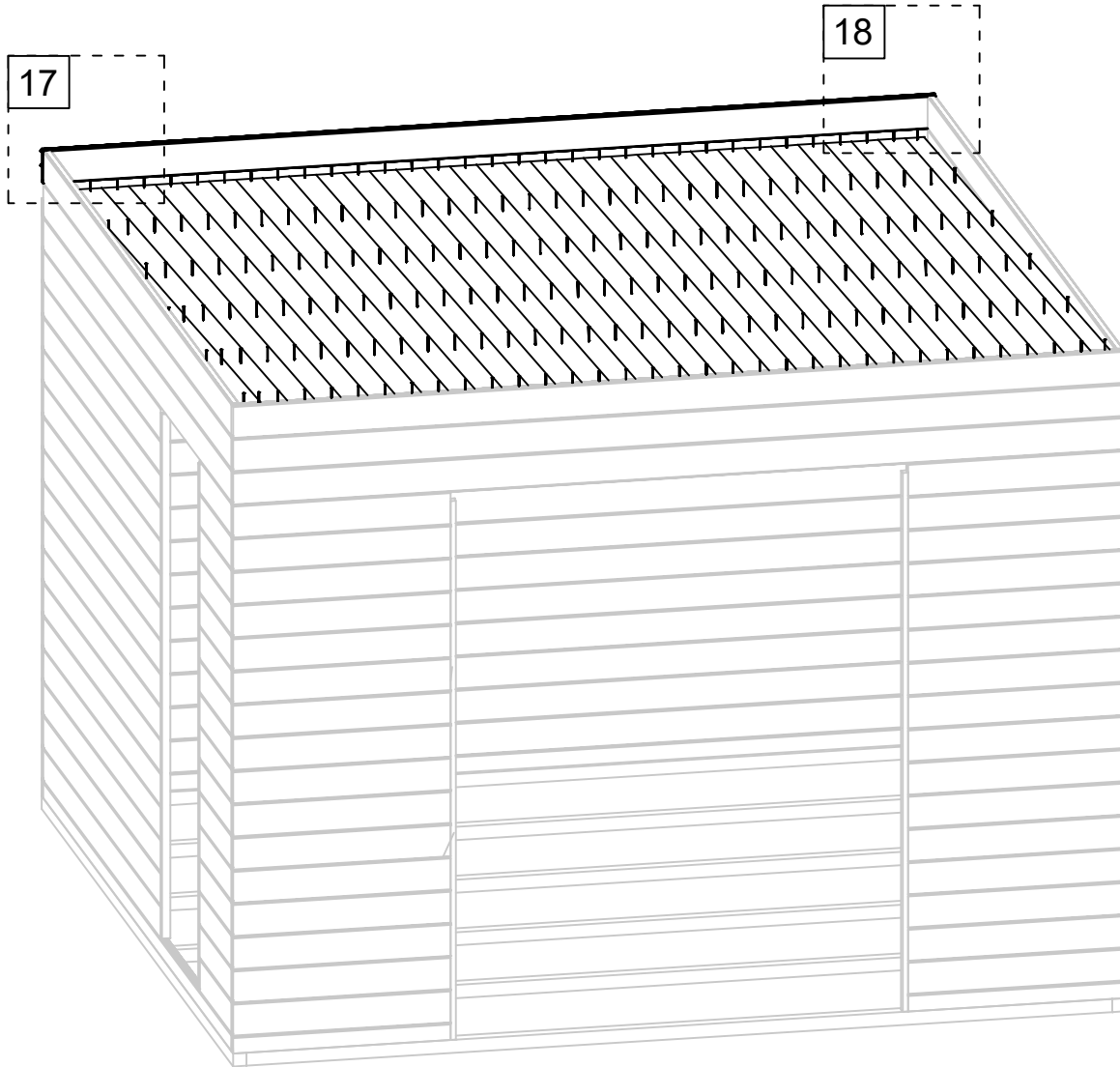

17.01.2023

19/23

Art. Nr. 2853400

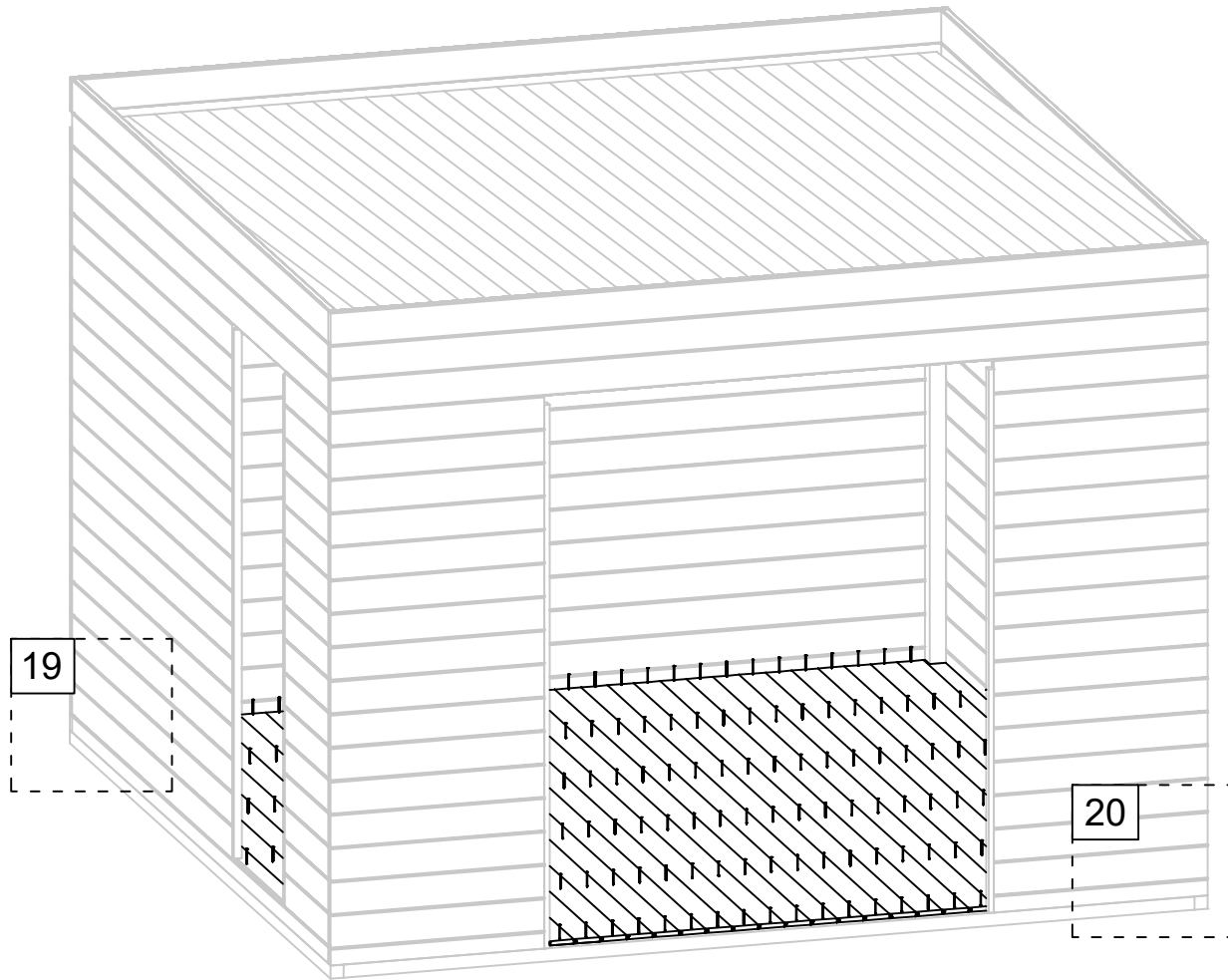

19

20

17.01.2023

19

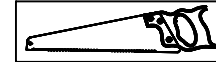

5,5

5,5

NF4

20

NF4

5,5

5,5

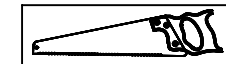



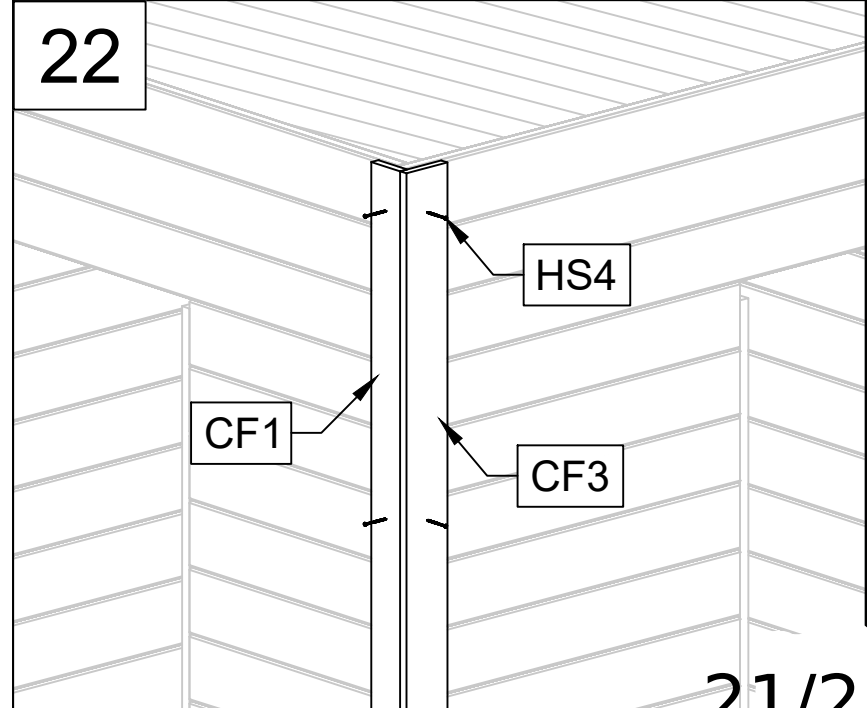
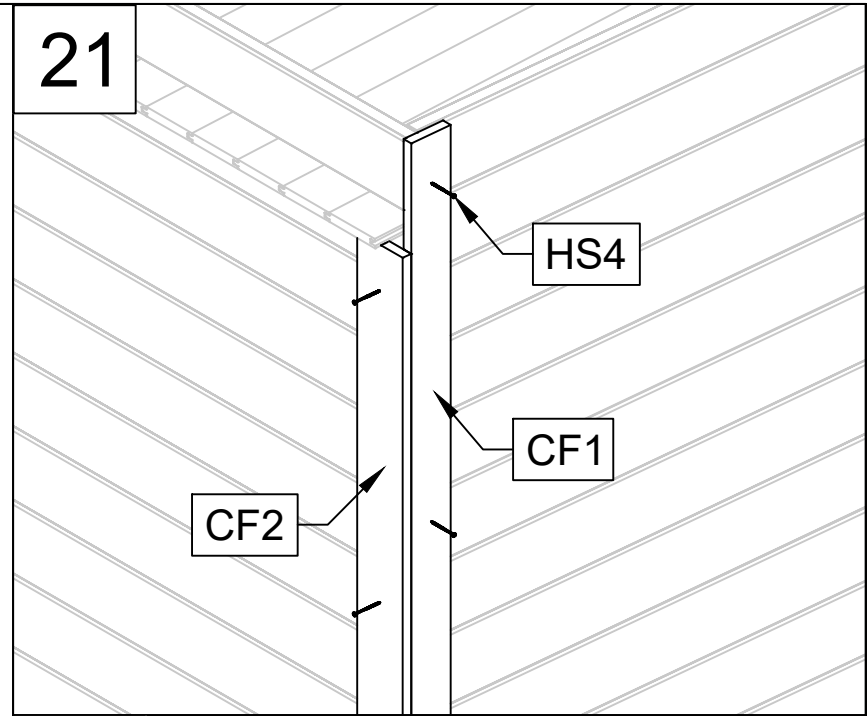
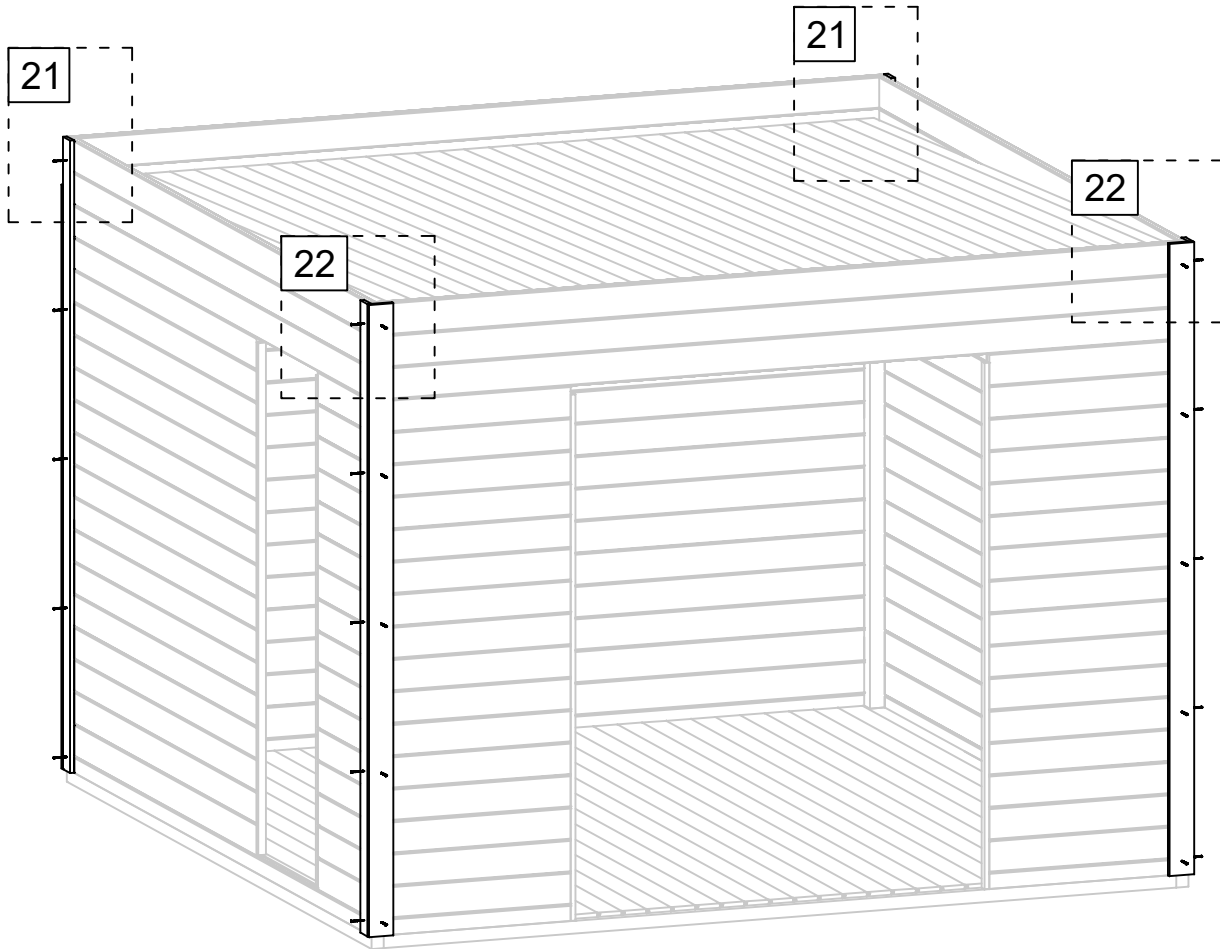

20/23

Art. Nr. 2853400

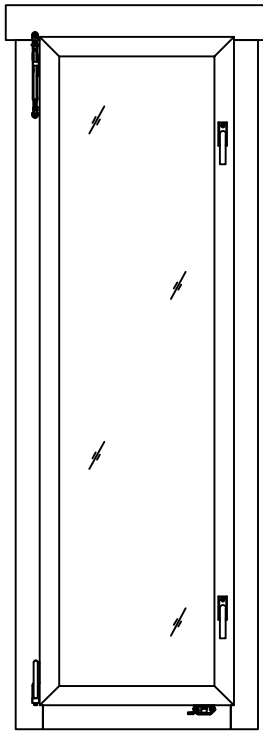
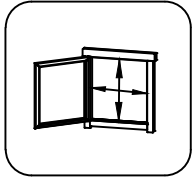

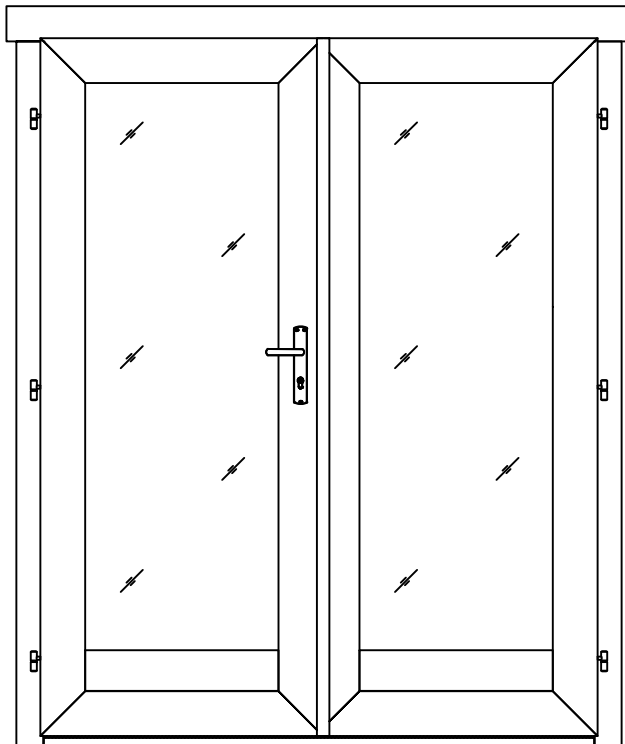
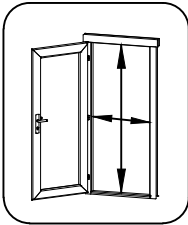
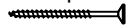
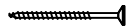
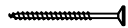
17.01.2023

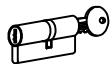
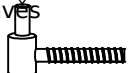
Pos	29.01.2016 Piece list - Stückliste - Liste des pièces - Elementi - Stuklijst - Tükítabel <b>Kusovník</b> 560x1780 AK.1.100.SSV SGC	1/1	Q	P (mm)	L (mm)
	<p data-bbox="263 145 1292 179">Glass size - Glasgröße - Taille de la vitre - Misura del vetro - Glas afmeting - Klaasi mõõt: 416x1636 mm</p> <div data-bbox="718 224 981 952" style="text-align: center;">  </div> <div data-bbox="1165 201 1316 235" style="text-align: right;">Rozměr skla</div> <div data-bbox="1332 145 1524 324" style="text-align: right;">  </div> <div data-bbox="1356 336 1500 369" style="text-align: right;">460x1680 mm</div>				
FS1	<p data-bbox="263 2038 1165 2094">Window handle fittings - Fenstergriff - Poignée de fenetre - Maniglia c/ferramenta - Raamhendel -/grendel -/klink - Aknalink Kování okenní kliky</p>	2			
FSP	<p data-bbox="263 2116 1165 2195">Bolt for window handle fittings - Bolzen für fenstergriff beschlag - Vis pour fixation poignée de fenetre - Bullone x apertura manuale finestre - Schroef voor raamhendel - Akna käepideme polt Šroub pro kování okenní kliky</p>	4			

Pos	Piece list - Stückliste - Liste des pièces - Elementi - Stuklijst - Tükítabel 27.11.2017 <b>Kusovník</b> 1494x1850 TUK.1.100.SVV.MMc SGC	1/1	Q	P (mm)	L (mm)
	<p>Glass size - Glasgröße - Taille de la vitre - Misura del vetro - Glas afmeting - Klaasi mõõt: 514x1486 mm</p> <p>Rozměry skleněné tabule</p>   <p>1394x1768 mm</p>				
	<b>23/23</b>				
HS4	Screw for door fillet - Schraube zur befestigung türleiste - Vis pour fixation baguette d'arret de porte - Viti per massellino della porta - Schroef voor deurlijst - Krugi ukse kokkuvaltssiliistule		Šroub pro dveřní lištu	5	3x30
HS16	Screw for door jamb - Schraube für türrahmen - Vis de fixation partie haute avec montants du cadre de porte - Viti x fissaggio montanti porte - Schroef voor deurkozijn - Krugi ukse lengile		Šroub pro dveřní zárubeň	4	5x90
HS25	Screw for doorstep - Schrauben für swelle - Vis pour fixation barre de seuil - Vite per soglia della porta - Schroef voor deurdorpel - Krugi lävepakule		Šroub pro dveřní práh	3	4.5x65
TL4	Door handle fittings - Türgriff - Poignee de porte - Maniglie - Deurhendel / klink - Ukse käepide		Kování pro dveřní kliku	1	
TL5	Set of door lock covers - Schlossblenden - Set de garnitures de porte - Copertura serrature - Slot sluitplaat set - Ukse lukuplaat		Souprava krytů dveřního zámku	1	
	Cylinder lock - Zylinderschloss - Barillet de porte - Serratura - Cylinder slot - Ukse lukusüdamik		Cylindrická vložka dveřního zámku	1	30x35
	Male bolt hinge for door - Türband - Partie male de paumelle de porte - Cerniera anube x porta - Scharnier bout - Ukse polthing isane		Vnější šroubový dveřní záves	6	
	Striker for barrel bolt - Hülse für grendelriegel - Gache au sol du targette - Boccola per fermo della porta - Huls voor vergrendelingsschuif - Vasturaud ukse servariivile		Čepička pro zarážku dveří	2	